

BRUKER NANO ANALYTICS

Gem Sapphires: Understanding their Origins and Quality The Benefits of Combining micro-XRF and SEM-EDS

Andrew Menzies (PhD) Senior Applications Scientist Geology and Mining

Invited Speaker:

Gustavo Miranda-Diaz (Dipl. -Geol.) PhD candidate, Institut für Mineralogie, Technische Universität Bergakademie Freiberg, Germany

Gem Minerals: Sapphire Origins and Trace Elements

The benefits of combining micro-XRF and SEM-EDS

01 Overview

04 Results Discussion

02 Analytical Introduction

05 General Comments

03 Sapphires: Origins

06 Summary and Conclusions

Presenters



Andrew Menzies, PhD
Sr. Applications Scientist
Geology and Mining,
Bruker Nano Analytics, Berlin,
Germany



Gustavo Miranda-Díaz,
Dipl. -Geol. PhD Candidate
Freiberg University of Mining
and Technology, Freiberg,
Germany

GEM MINERALS: SAPPHIRE ORIGINS AND TRACE ELEMENTS
THE BENEFITS OF COMBINING MICRO-XRF AND SEM-EDS

Introduction

Overview:

The motivation and analytical challenge:

Gem quality minerals are primarily dependent on the presence (or lack thereof) of trace elements and inclusions.

In addition, such information also enables an understanding of the origins of these minerals and the environment in which they occurred.

Specifically, in the case of **sapphires**, a type of **corundum** (Al_2O_3), the presence of trace levels of Fe, Ti, and Cr predominantly determine the colour and its intensity.

Identification of inclusions in the sapphires and mineral associations in lithological units will yield information on the geological process and the associated pressure – temperature (P-T) constraints.

Combined with other techniques, such datasets can help the understanding of deposit formation.

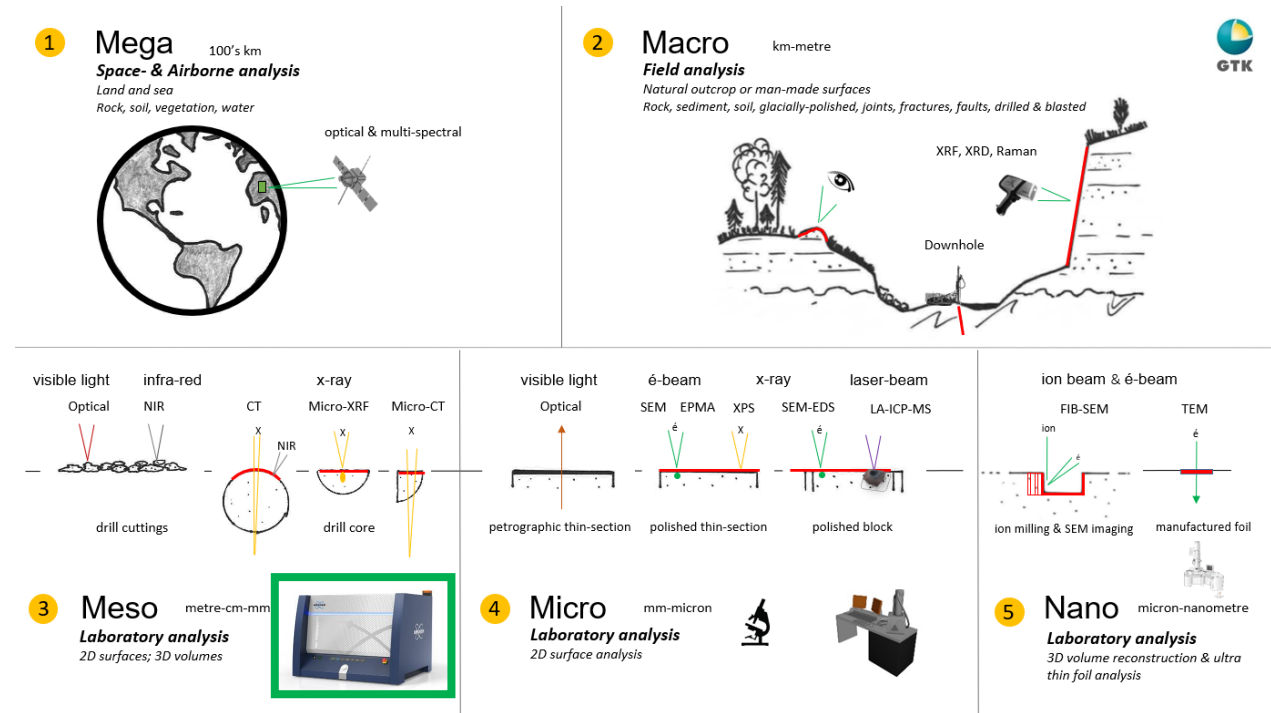

Butcher AR (2020) Upscaling of 2D mineralogical information to 3D volumes for geoscience applications using a multi-scale, multi-modal and multi-dimensional approach. *EMAS 2019, Conference Proceedings Volume, Trondheim, 19-23 May 2019.*

Overview: Analytical Challenge – Multiple Samples of Different Sizes

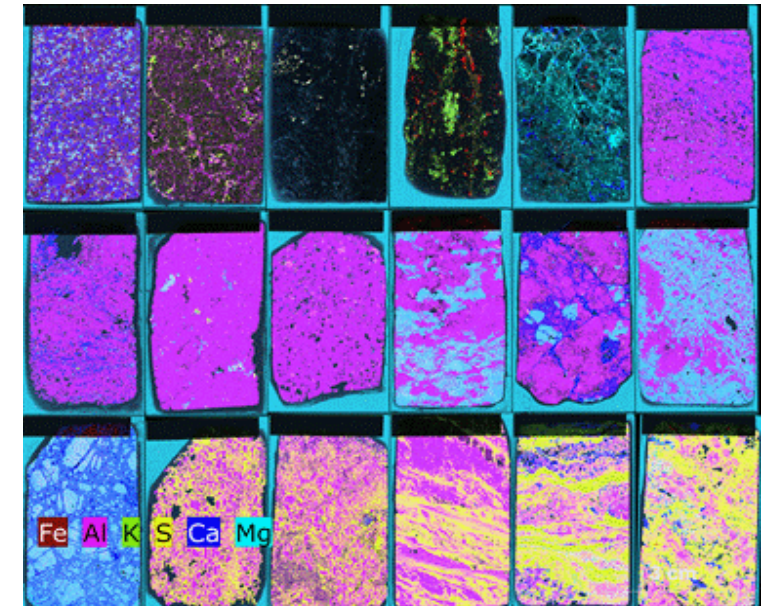
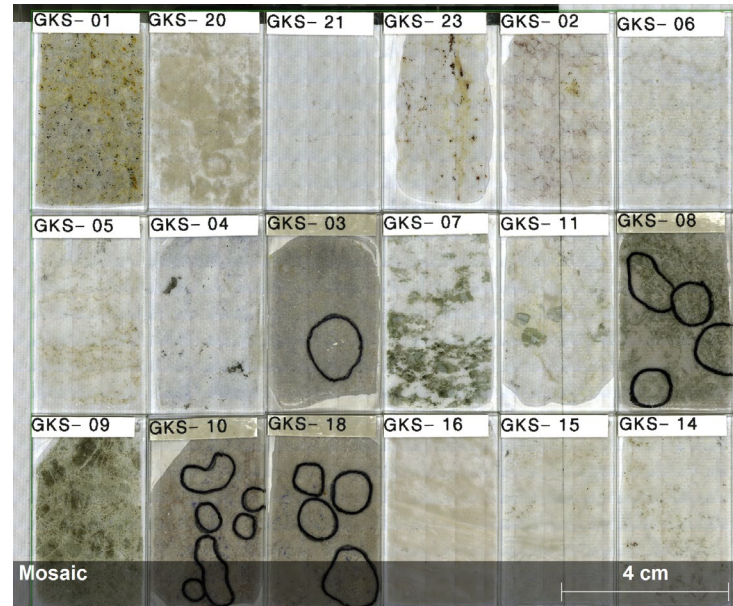

Micro-XRF (M4 Tornado) can analyse samples of different sizes:

Left: Field Rock Samples to
Top Right: Thin Sections to
Bottom Right: Individual Crystals

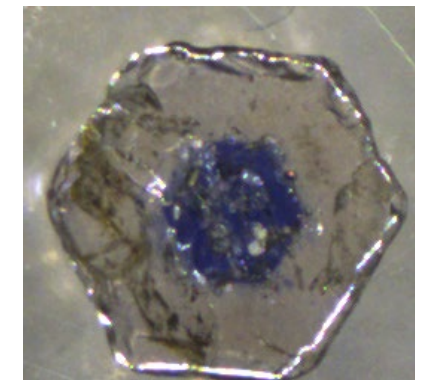
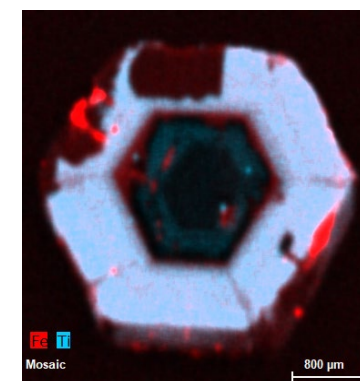

Overview:

Analytical techniques

Benchtop micro-XRF:

Micro-XRF is spatially resolved X-ray fluorescence analysis. The high spatial resolution is achieved by using a focusing polycapillary x-ray optic. Generated fluorescent signal is analyzed using one or two SDDs.

Scanning electron microscope (SEM) and analytical add-on options

The SEM is a well-known analytical technique based on electron beam spatially resolved imaging and elemental composition analysis using Energy Dispersive Spectrometers (EDS). Additional options such as wavelength dispersive spectrometers (WDS) as well as focused X-ray beam sources have been added to complement the analytical capabilities.

Micro-XRF **M4 Tornado Plus**



SEM-EDS: **Quantax** Micro-XRF: **XTrace**

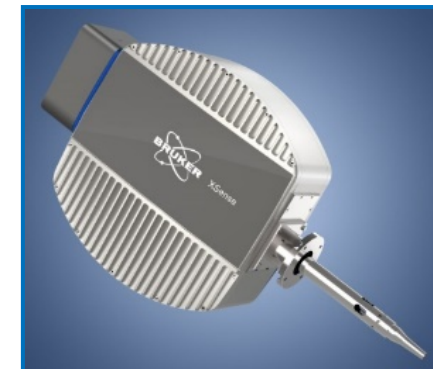
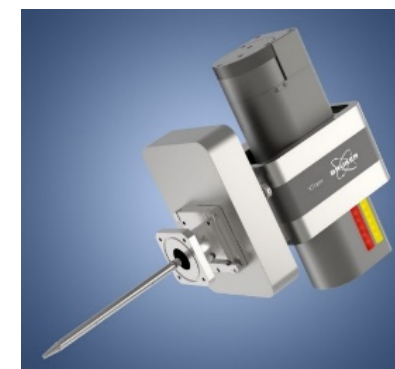

Overview: Micro-XRF as an analytical technique

Main analytical advantages of micro-XRF

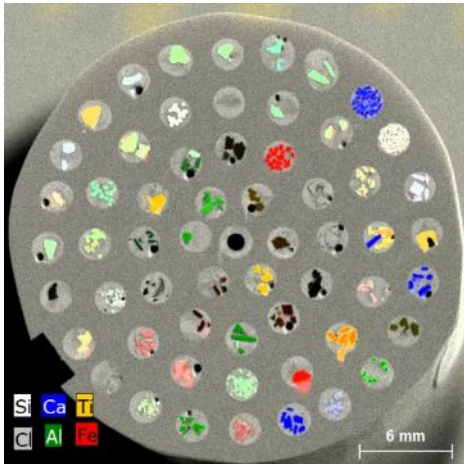

No sample preparation

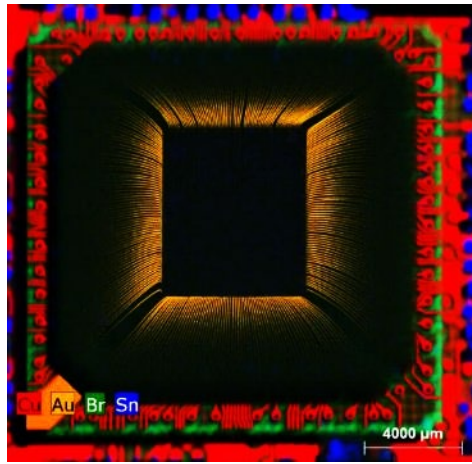

Information from the depth of the sample

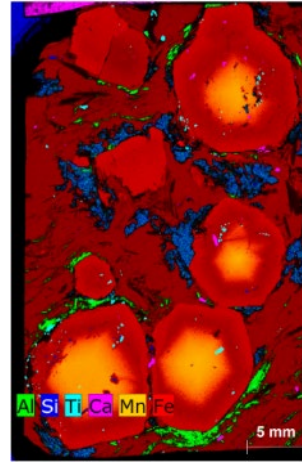

Trace element sensitive

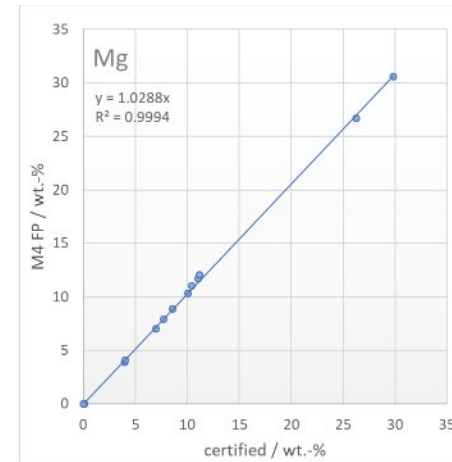

Reference samples free and standard supported quantify-cation options



Analytical differences:

- **M4 Tornado Plus** as a benchtop instrument allows faster scan of larger samples and heavier sample (up to 30 cm and 7 kg) at higher resolution
- **XTrace** as an ad-on technique allows to combine the advantages of micro-XRF with the associated SEM options (high spatial resolution of the E-Beam and resolution of the WDS)

Overview: Scanning Electron Microscopy (SEM) and analytical options

Analytical advantages of SEM-EDS and SEM-WDS relevant for this work

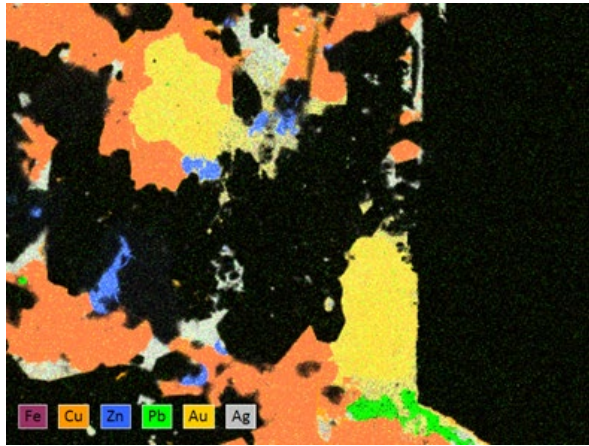

High spatial resolution

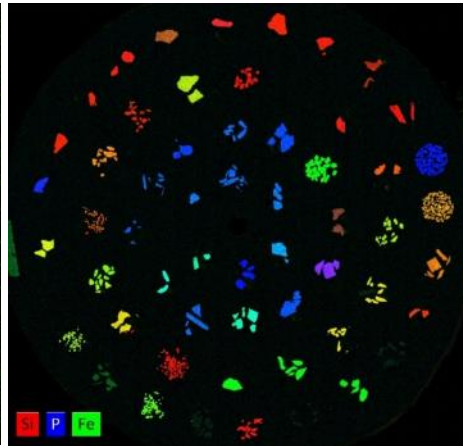

Multiple quantification options: standardless and standard-based

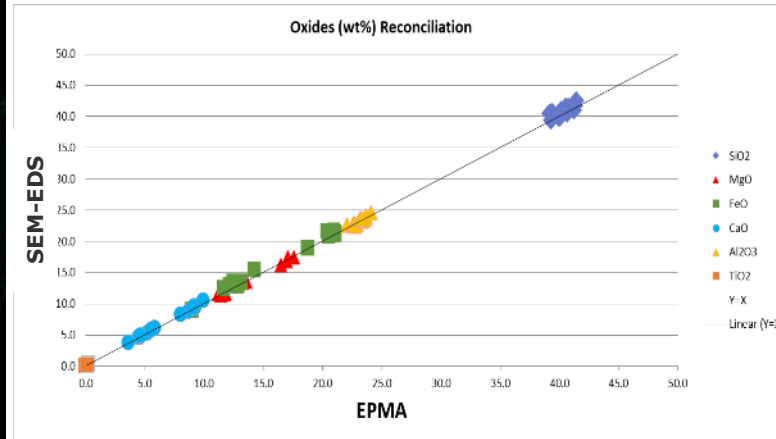

SEM-EDX: Quantax



121 eV*

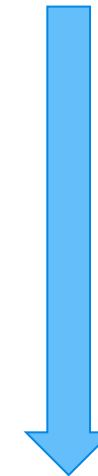

4 eV**

SEM-WDS: XSense

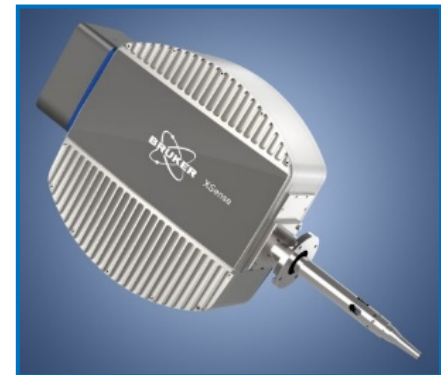

SEM-EDS-WDS: Analysis based on the sample interaction with an electron beam source from the SEM and the resultant X-rays that are detected using either an SDD or WDS.

* For 121 eV for Mn Ka (equivalent to 73 eV for a Si Ka), ** for Si Ka

X-ray Fluorescence and Electron Excitation Analysis

Excitation with either electrons or X-rays generate fluorescence radiation of the irradiated material.

Detection is normally performed with energy dispersive spectrometers (EDS), independent of the excitation source. Signal collection and spectral presentation is identical, but quantification is different.

Main differences:

- Spot Size
- Information depth
- Elemental Range (Energy)
- Limits of detection (Concentration)
- Spectral Background
- Sample Handling

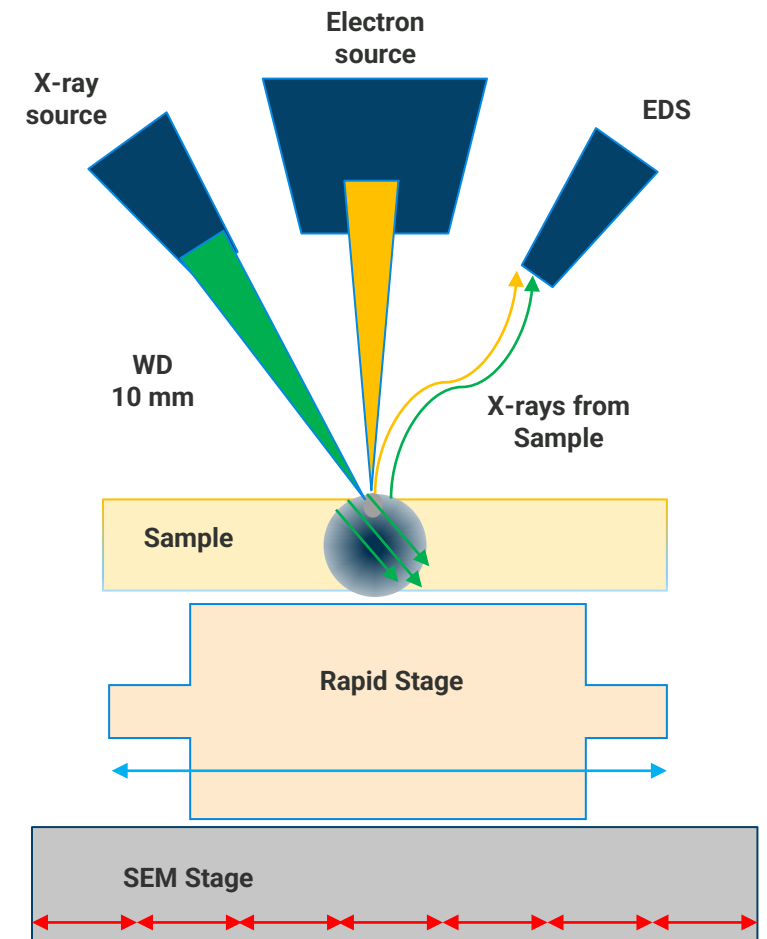

GEM MINERALS: SAPPHIRE ORIGINS AND TRACE ELEMENTS
THE BENEFITS OF COMBINING MICRO-XRF AND SEM-EDS/WDS

Gem Sapphires: Understanding their Origins and Quality

The Benefits of Combining micro-XRF and SEM-EDS



TECHNISCHE UNIVERSITÄT
BERGAKADEMIE FREIBERG

Die Ressourcenuniversität. Seit 1765.

DAAD

Deutscher Akademischer Austauschdienst
German Academic Exchange Service

Origin of sapphire deposits, Portezuelo de Pajas Blancas area: mineralogical, geochemical and crystallographic aspects from the Atacama Region – Chile.



Gustavo Miranda-Díaz*^{1,2}

¹ Departamento de Geología, Facultad de ingeniería, Universidad de Atacama, Avenida Copayapu 485, Copiapó, Chile.

² Mineralogie Institut, Technische Universität Bergakademie Freiberg,, Brennhausgasse 14, 09599 Freiberg , Germany.

*gustavo.miranda@uda.cl



GEM MINERALS: SAPPHIRE ORIGINS AND TRACE ELEMENTS
THE BENEFITS OF COMBINING MICRO-XRF AND SEM-EDS

Part 1: Sapphires - General Information

Corundum (Sapphires): Introduction - General Properties

- The mineral corundum is an **aluminum oxide** Al_2O_3
- **crystallographic system:** Trigonal
- **Hardness:** 9 mohs scale
- **Member of:** Hematite group
- **Colour:** Colorless (pure)
- **Geological setting:** Genetically associated with Al-rich and Si-poor igneous and metamorphic environments



Picture: Mindat.org

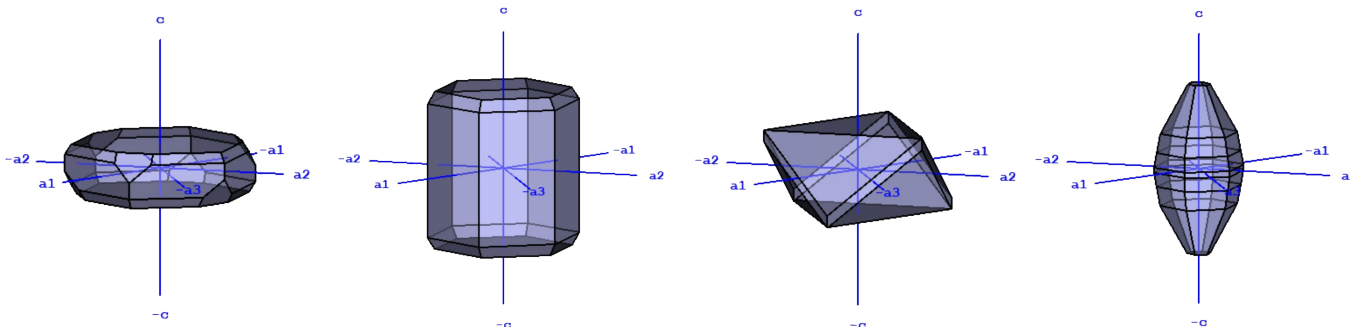

Corundum:

Introduction: Colours

- The different colours of corundum are due to impurities called chromophores.
- These chromophores generally substitute the Al^{3+} in the internal mineral structure.
- Sapphires can be range of colours: blue, pink, violet, green, yellow, orange
- Rubies can be: red

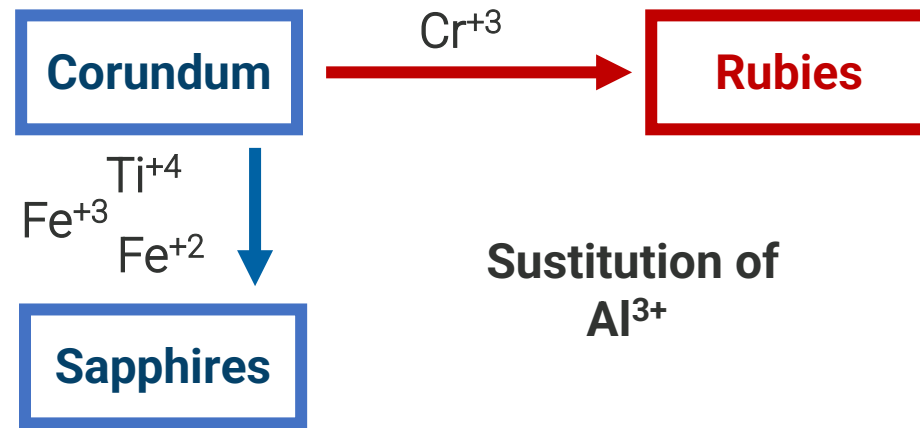

Corundum: Introduction - Source of Corundum

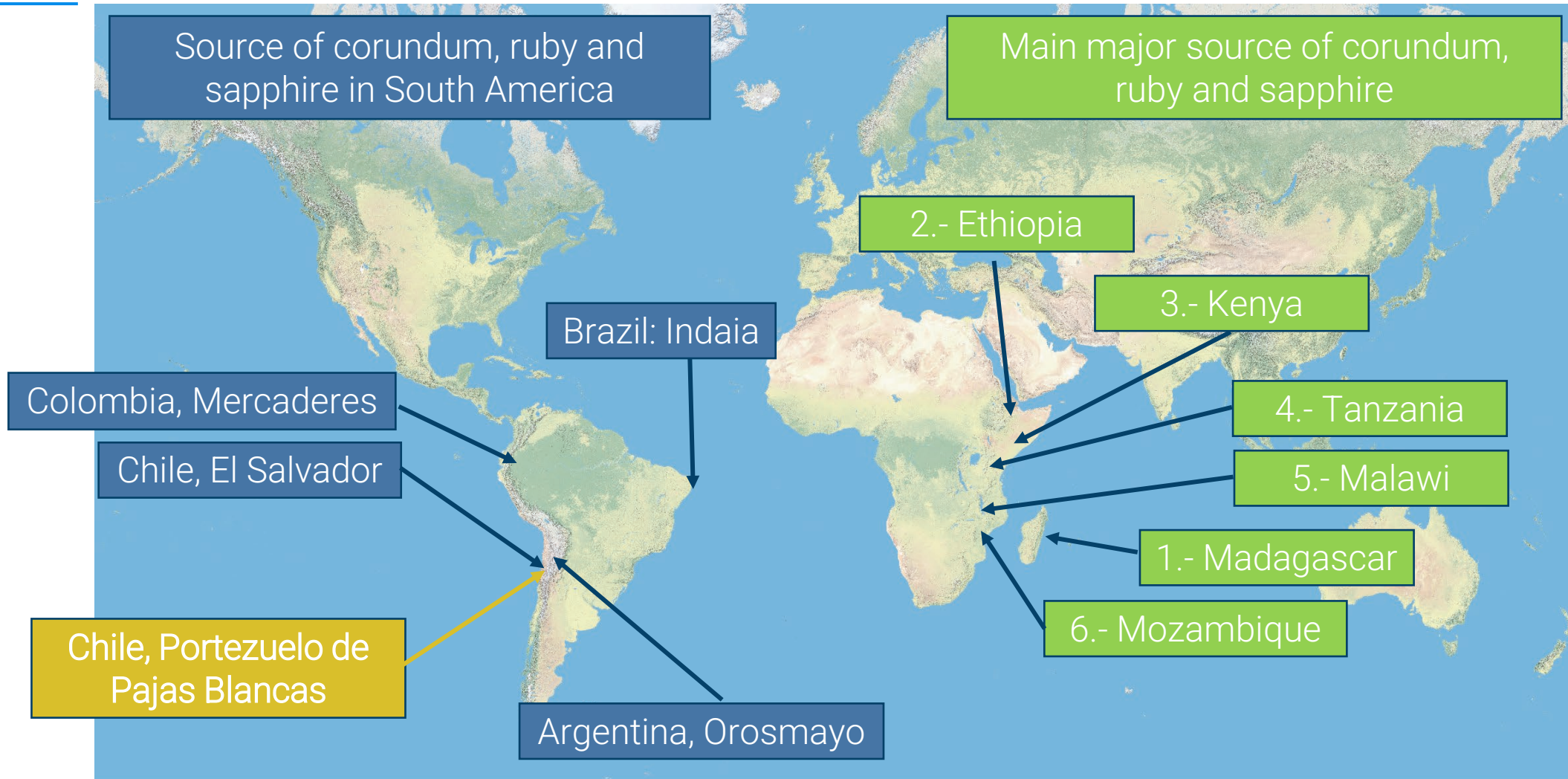

Part 2: Sapphire-bearing rocks from Portezuelo de Pajas Blancas, northern Chile.

Geology and petrography

Sapphires:

The unusual sapphires from Chile – Portezuelo de Pajas Blancas area

The Portezuelo de Pajas Blancas deposit, located in northern Chile, represents a unique opportunity to constrain unusual geological processes involved in the genesis of sapphire-rich metasomatites in the central Andes.

This deposit was discovered in 2003 by the company Exploraberg.

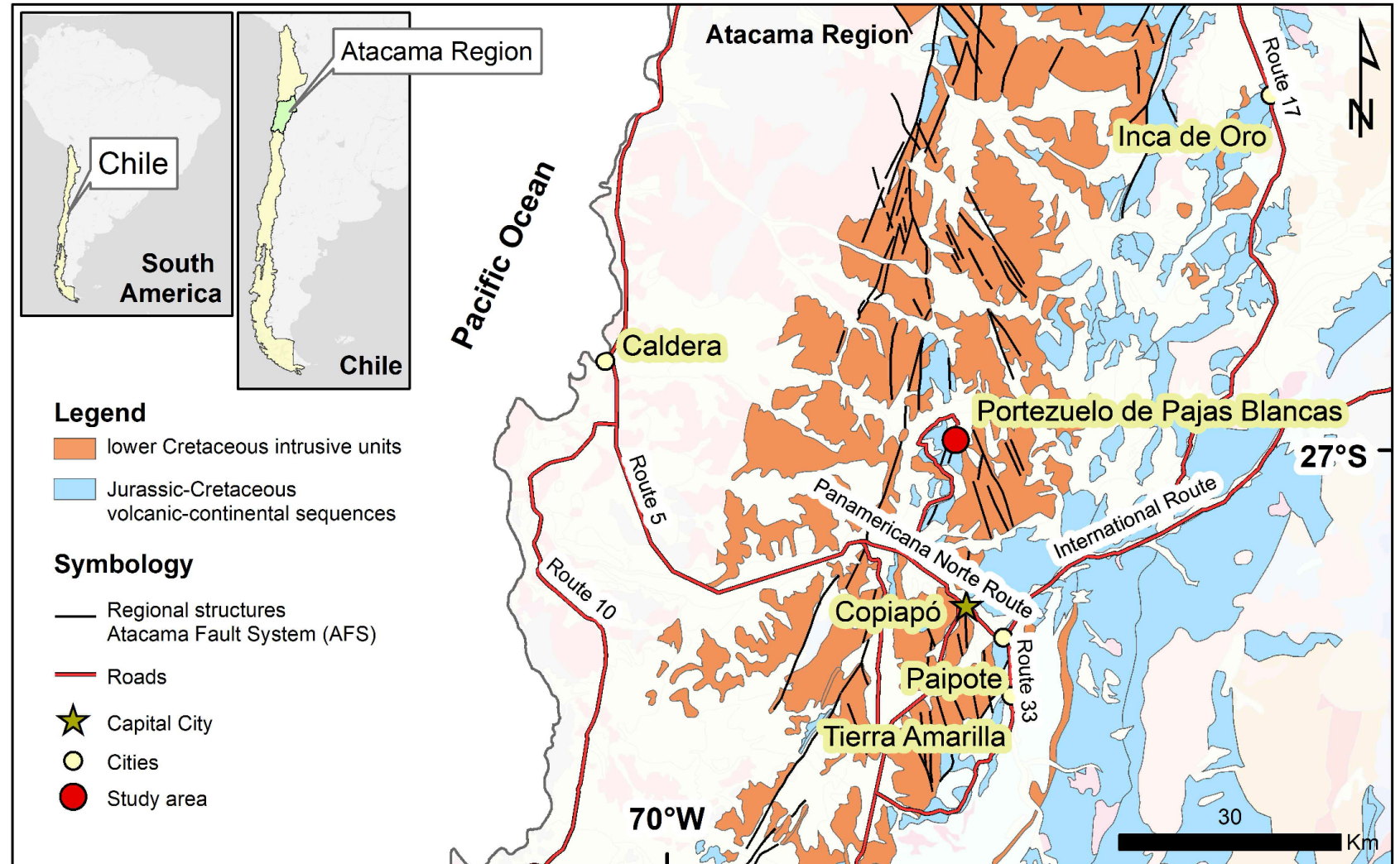

Sapphires:

Portezuelo de Pajas Blancas Deposit - Location

Portezuelo de Pajas Blancas

Geological information:

Surface geological mapping at the scale of 1:15.000 and 1:5000

Sample preparation:

Sapphire-rich rocks and sand
Density separator (JIG)

Petrographic information:

Subcommission on the Systematics of Metamorphic Rocks (IUGS).
Optical Microscope

Mineralogical information:

Optical microscope
XRD analysis
Automated Mineralogy

Geochemical Information:

Micro-XRF (M4 tornado)
SEM-EDX
Automated Mineralogy



Sapphires:

Results: Qualitative XRD analysis - Minerals

Mineral Name	Chemical Formula
Corundum (Crn)	Al_2O_3
Diaspore (Dsp)	$\alpha\text{-AlO(OH)}$
Böhmite (Bhm)	$\gamma\text{-AlO(OH)}$
Tourmaline Group (Tur):	
<i>Dravite (Drv)</i>	$\text{Na(Mg}_3\text{)Al}_6\text{(Si}_6\text{O}_{18}\text{)(BO}_3\text{)}_3\text{(OH)}_3\text{(OH)}$
<i>Magnesiofoitite</i>	$(\square, \text{Na})(\text{Mg}_2\text{Al)Al}_6\text{(Si}_6\text{O}_{18}\text{)(BO}_3\text{)}_3\text{(OH)}_3\text{(OH)}$
<i>Olenite</i>	$\text{Na(Al}_3\text{)Al}_6\text{(Si}_6\text{O}_{18}\text{)(BO}_3\text{)}_3\text{O}_3\text{(OH)}$
Alunite (Alu)	$\text{KAl}_3\text{(SO}_4\text{)}_2\text{(OH)}_6$
Sillimanite (Sill)	$\text{Al}_2\text{(SiO}_4\text{)O}$
Andalusite (And)	$\text{Al}_2\text{(SiO}_4\text{)O}$
Sericite (Ser)	$\text{KAl}_2\text{(AlSi}_3\text{O}_{10}\text{)(OH)}_2$
Quartz (Qz)	SiO_2
Apatite (Ap)	$\text{Ca}_5\text{(PO}_4\text{)}_3$
Rutile (Rt)	TiO_2
Calcite (Cal)	CaCO_3

Summary List of minerals identified by XRD for all of the lithologies identified at Portezuelo de Pajas Blancas

Sapphires: Portezuelo de Pajas Blancas - Lithological units

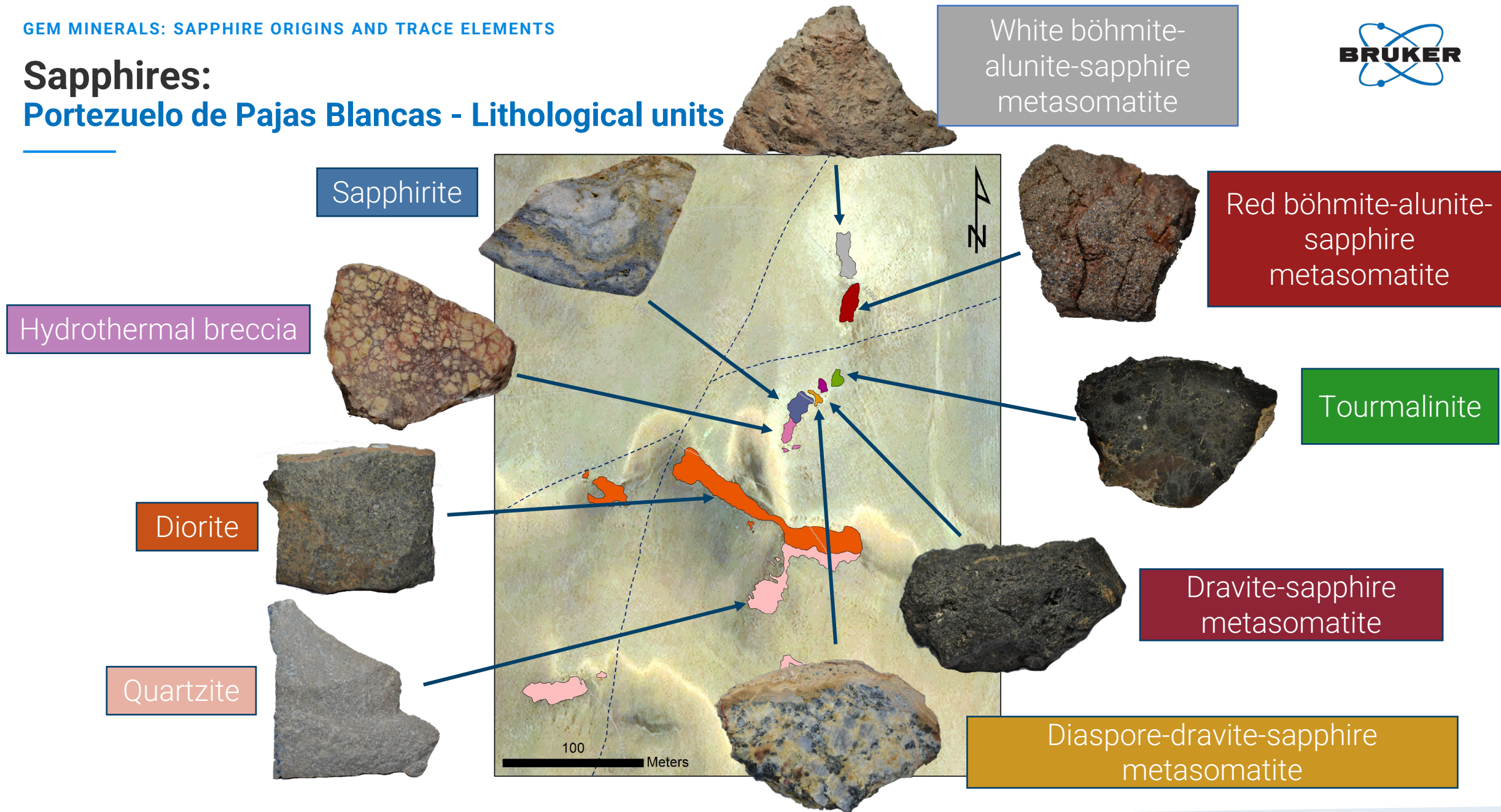

Sapphires:

Lithologies: Sapphire-bearing metasomatite (Sapphirite)

(a) Banded sapphirite hand sample, showing multi colours, discontinuous and centimetric bands. The bands display colourless, light blue, blue and dark blue colours associated with sapphire, whereas the yellow bands are associated with sapphire and diaspore.

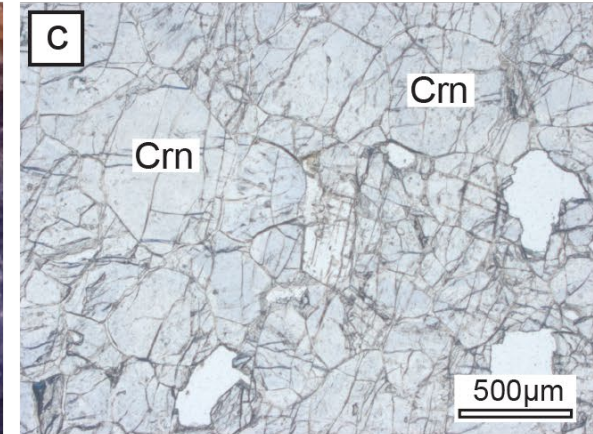
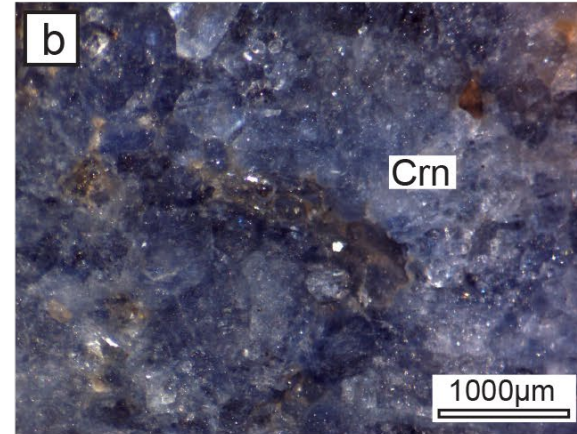

(b) Granoblastic blue sapphires and anhedral diaspore (binocular lens).

(c-f) Granoblastic and tabular sapphire crystals with lower amounts of diaspore, dravite and rutile (cross-polarized light and plane polarized light).

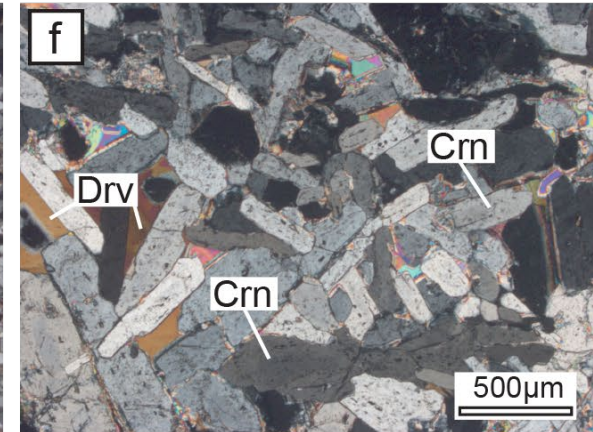
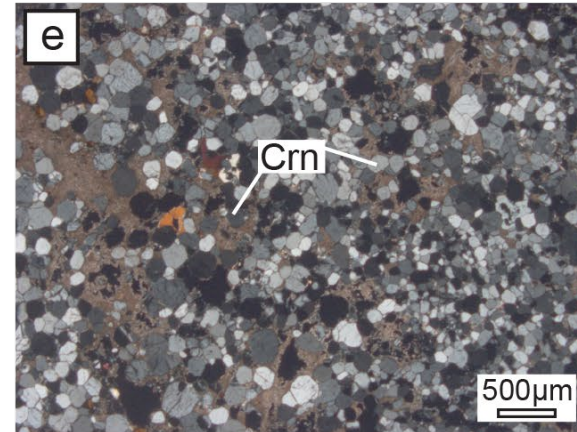
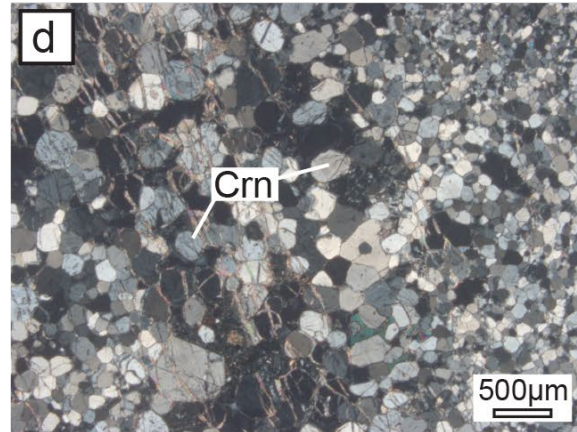

Sapphires:

Lithologies: Sapphire-bearing metasomatite (Sapphirite)

Scheme of a banded corundum metasomatite (Sapphirite). This lithological unit is composed almost entirely of corundum, which have different colors and form discontinuous and irregular bands.

These bands can be divided into:

- colorless (a and b),
- light blue (c),
- blue(d),
- dark blue (e).

The yellow tones are associated to the presence of diaspore.

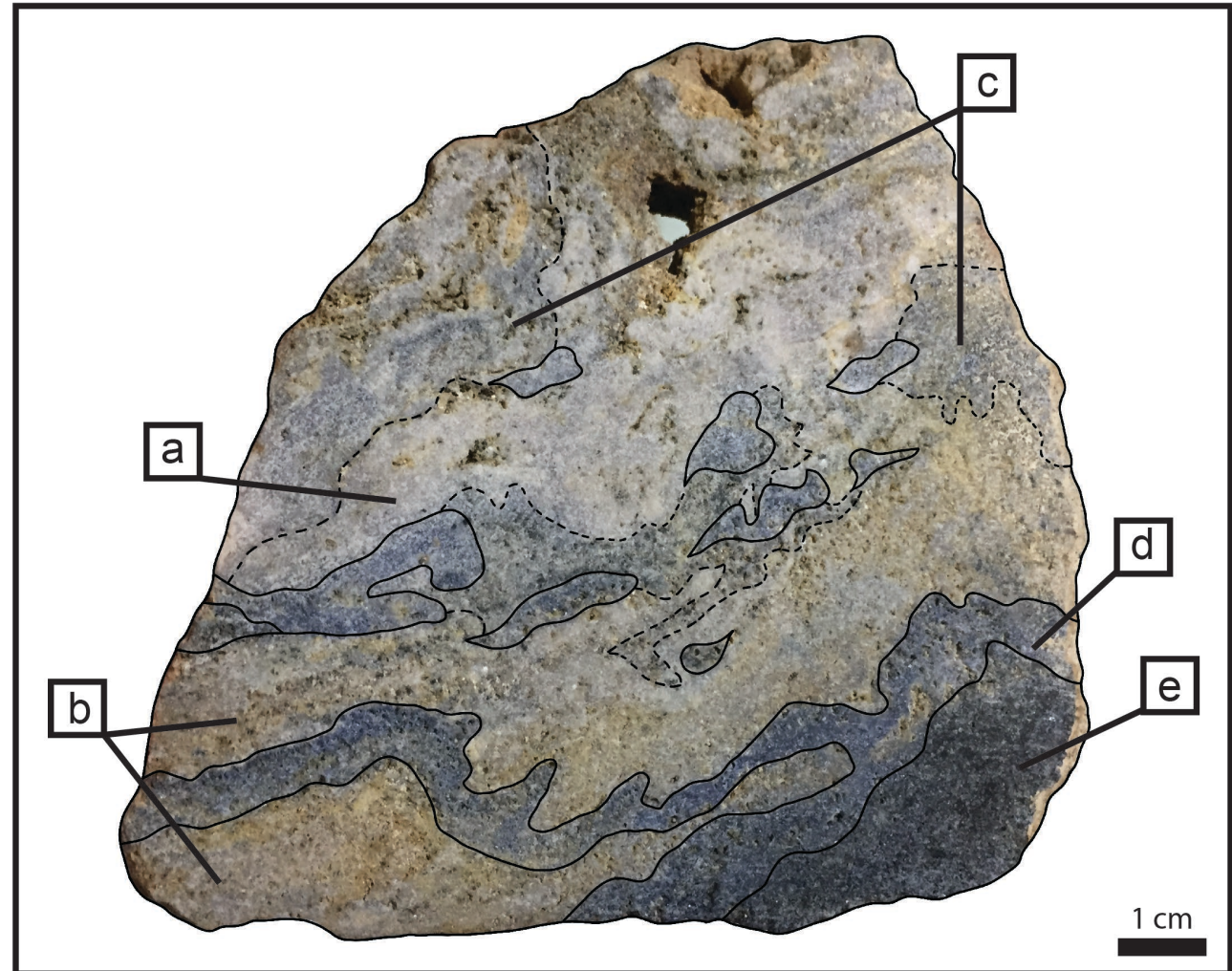

Sapphires: Lithologies: Sapphirite - Micro-XRF

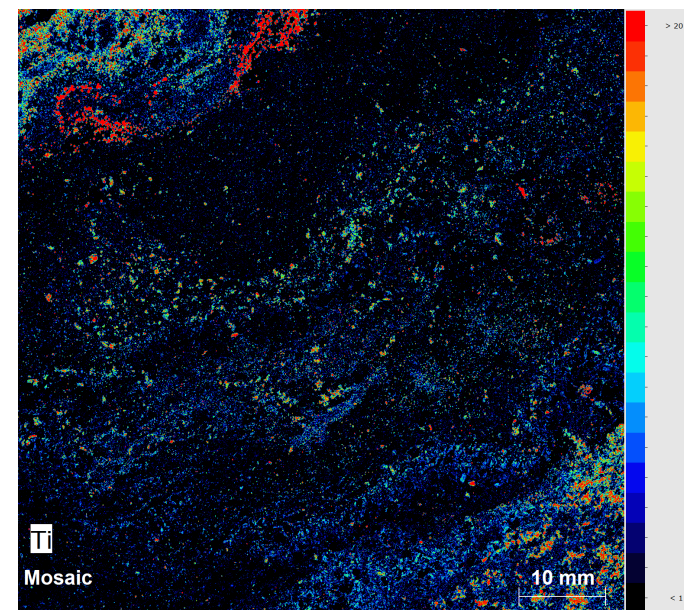
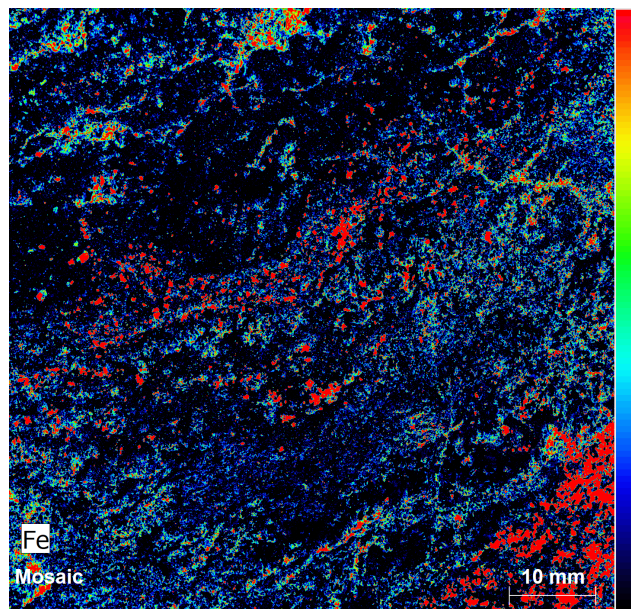
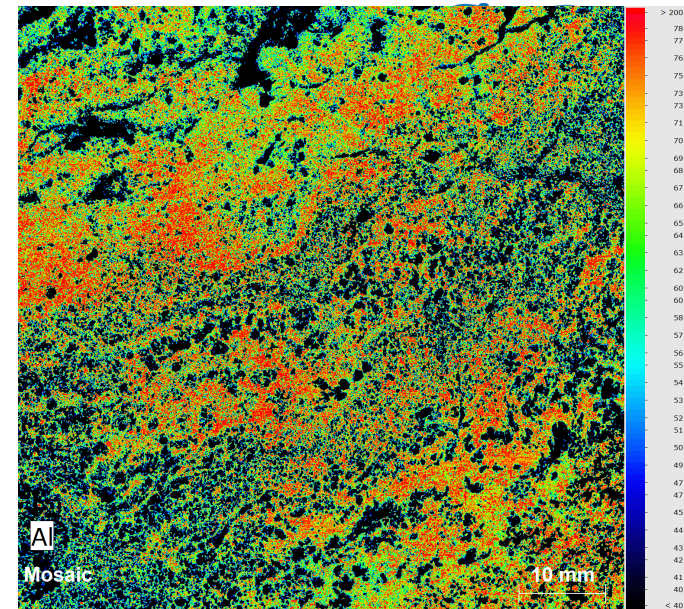
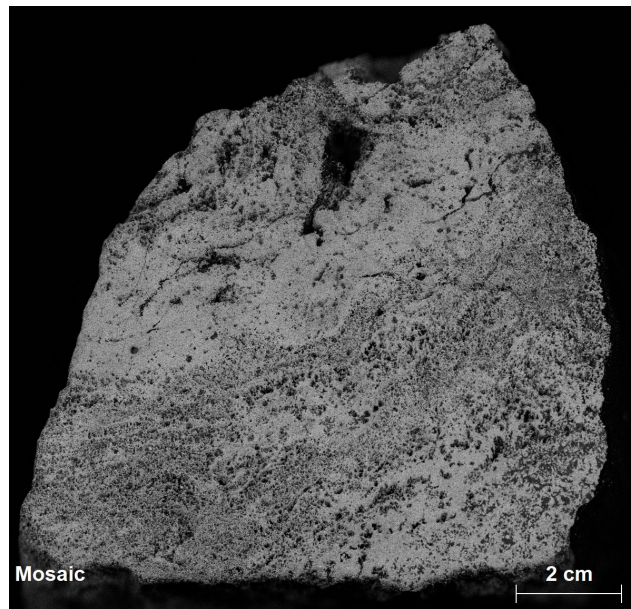
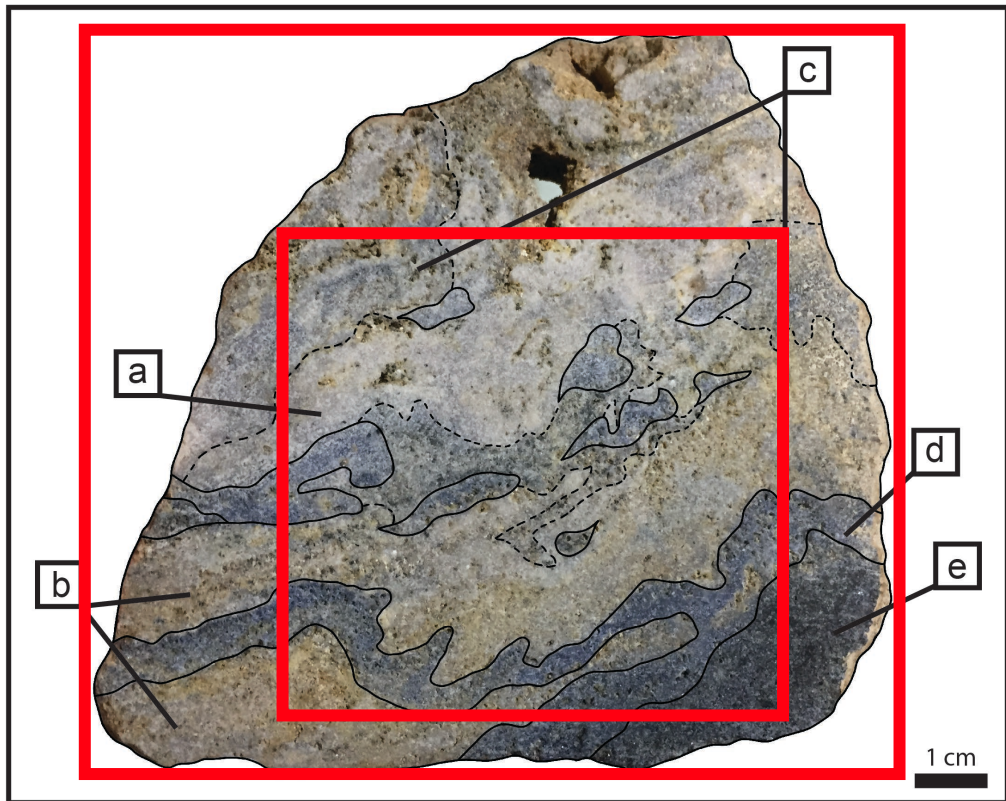

Sapphires:

Lithologies: Böhmite-alunite-sapphire metasomatite

Red Böhmite-alunite-sapphire metasomatites:

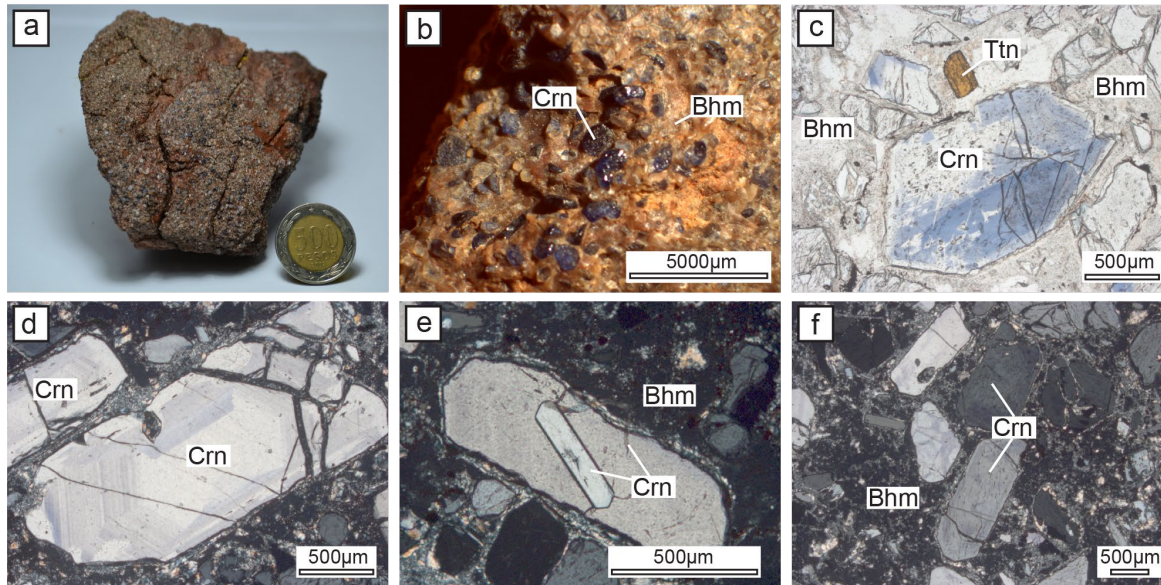

Red Böhmite-alunite-sapphire metasomatites:

- **(a)** Red böhmite-alunite-sapphire metasomatite hand sample.
- **(b)** Porphyroblasts of sapphire sapphire-type immersed in a red böhmite-alunite groundmass (binocular lens).
- **(c)** Euhedral sapphire crystal showing pleochroism, fine-grained böhmite and single crystal of titanite (plane-polarised light).
- **(d-f)** Zoned and fractured sapphire crystals (cross-polarised light).

White Böhmite-alunite-sapphire metasomatites:

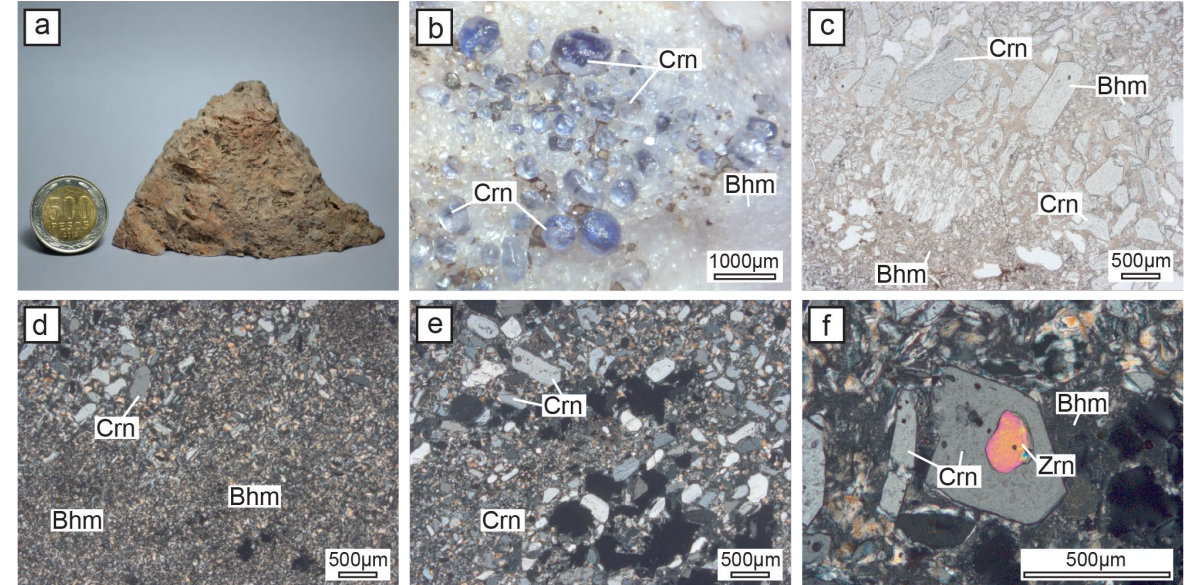

White Böhmite-alunite-sapphire metasomatites:

- **(a)** White böhmite-alunite-sapphire metasomatite hand sample.
- **(b)** Porphyroblasts of sapphire sapphire-type immersed in a white groundmass of böhmite-alunite (binocular lens).
- **(c-f)** Subhedral sapphire crystals immersed in a böhmite-rich groundmass (cross-polarized light and plane polarized light).

Sapphires:

Results: Micro-XRF - Böhmite-alunite-sapphire metasomatite

Böhmite-alunite-sapphire metasomatite

Optical Image

μXRF - Aluminium

μXRF - Aluminium

μXRF - Titanium

μXRF - Iron

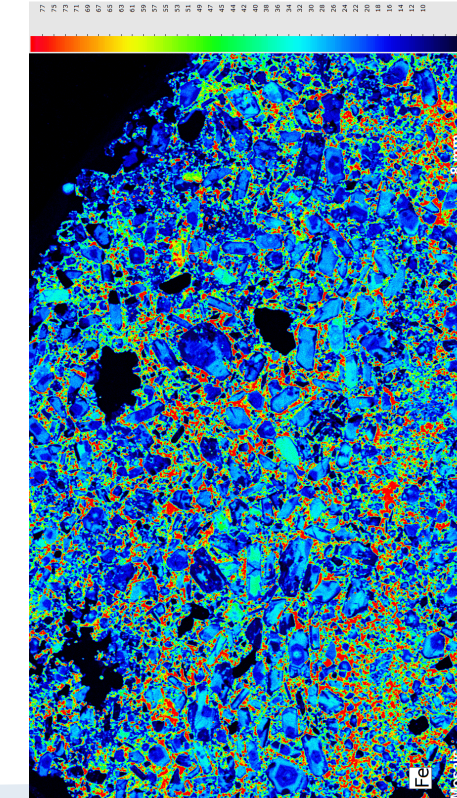
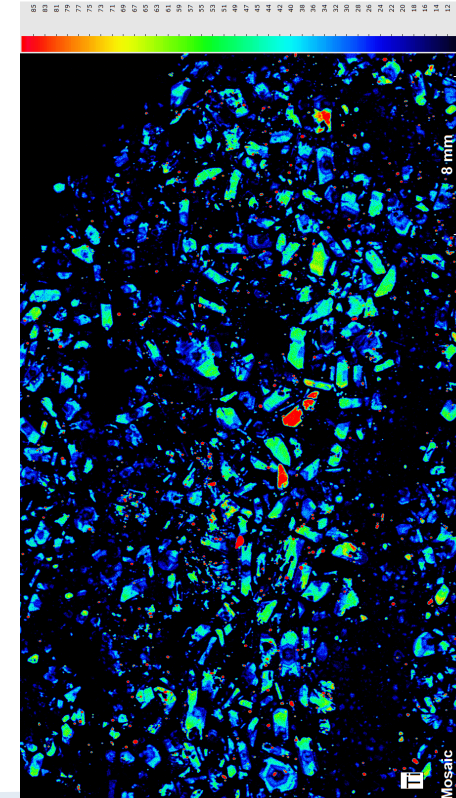
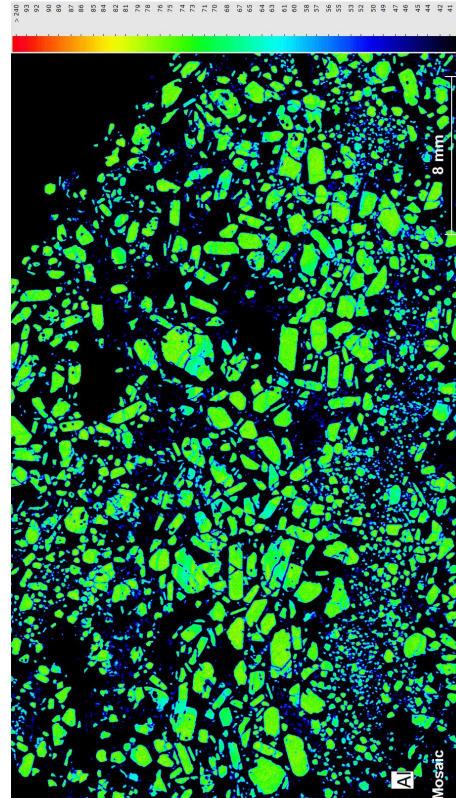
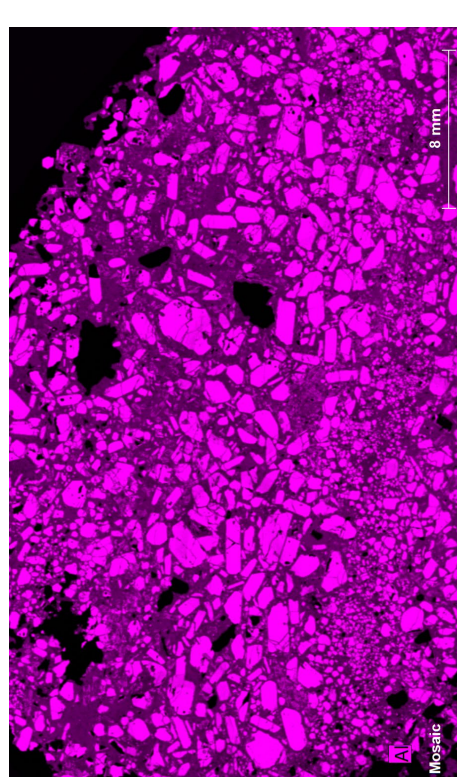
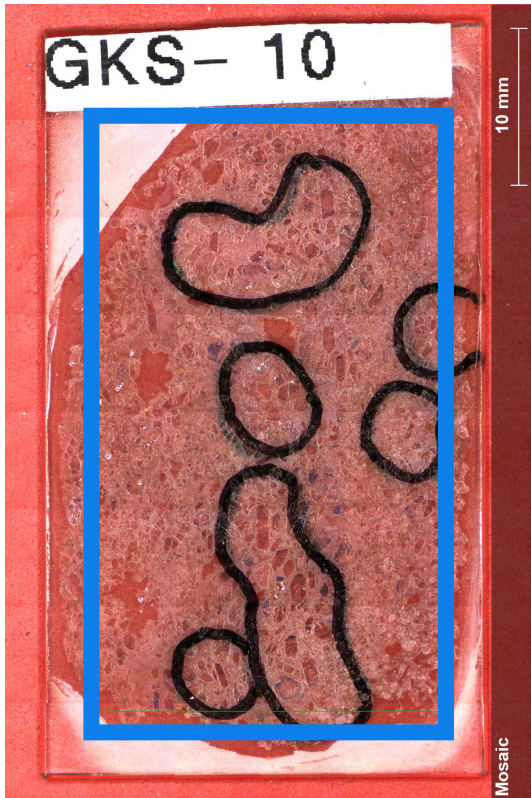

Sapphires:

Results: Micro-XRF - Böhmite-alunite-sapphire metasomatite

Böhmite-alunite-sapphire metasomatite

Optical Microscope
Plane Polarized Light

μ XRF - Titanium

μ XRF - Iron

μ XRF - Potassium

μ XRF - Sulphur

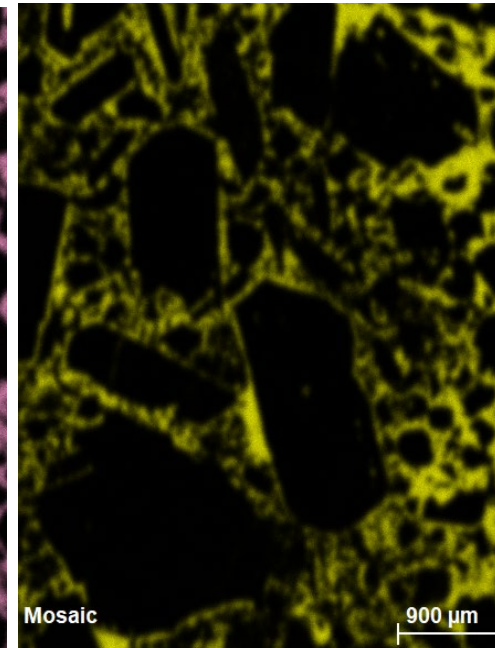
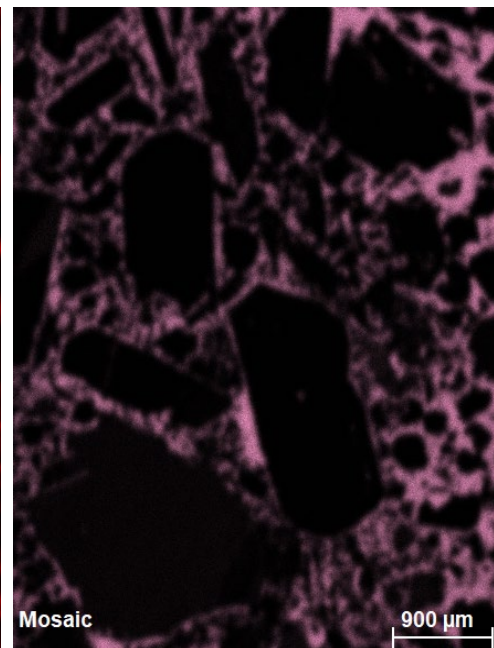
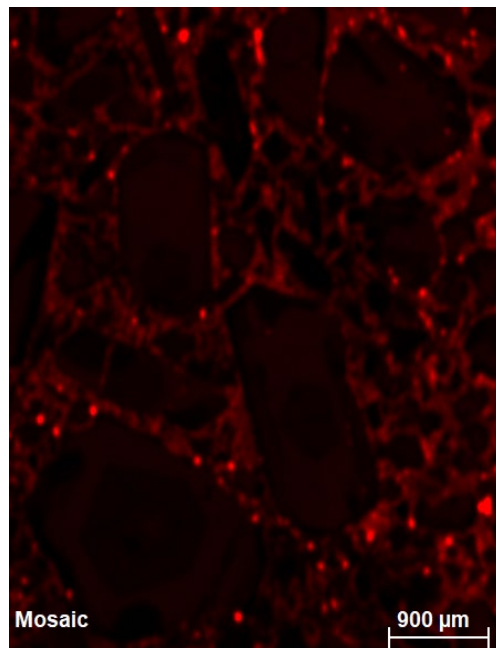
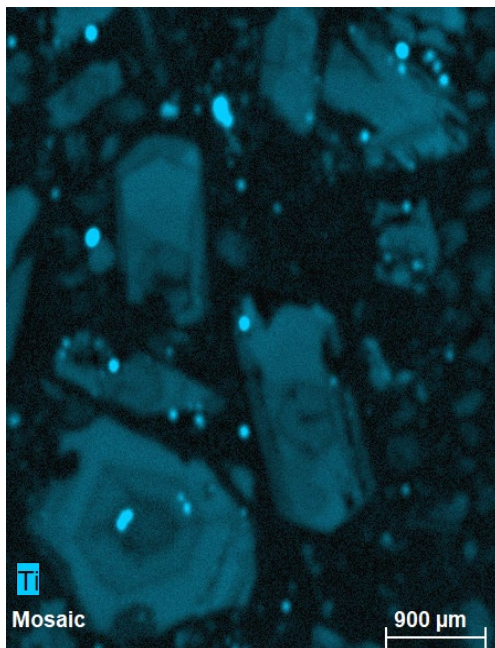
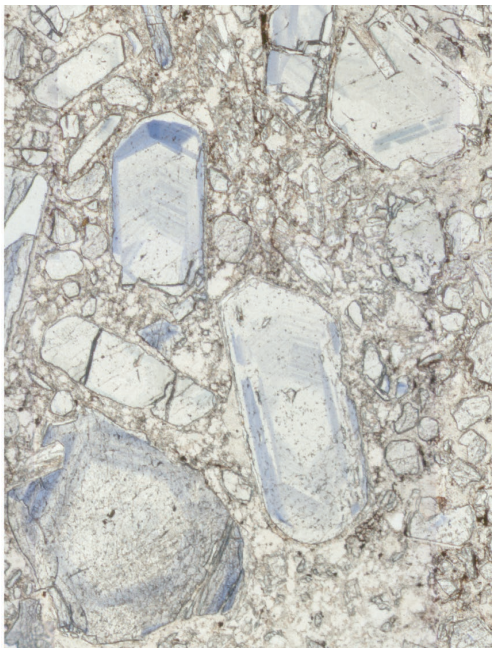

Sapphires:

Results: Micro-XRF - Böhmite-alunite-sapphire metasomatite

Böhmite-alunite-sapphire metasomatite

Optical Microscope
Plane Polarized Light

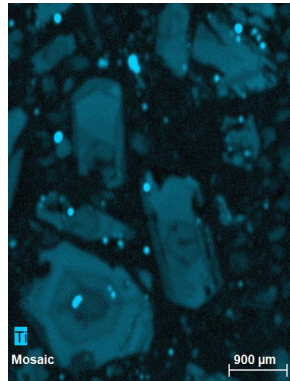
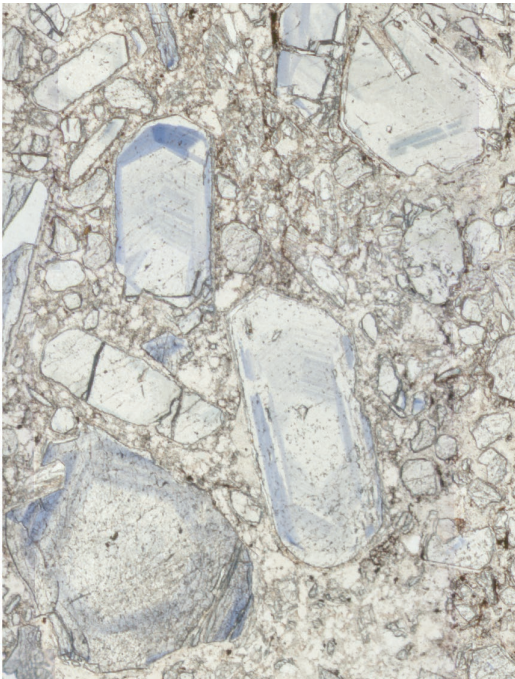

Micro-XRF - Titanium

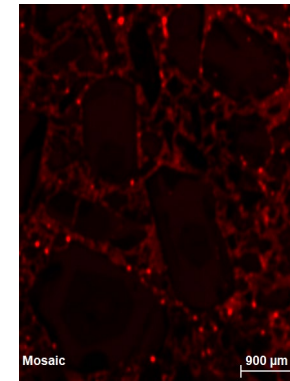
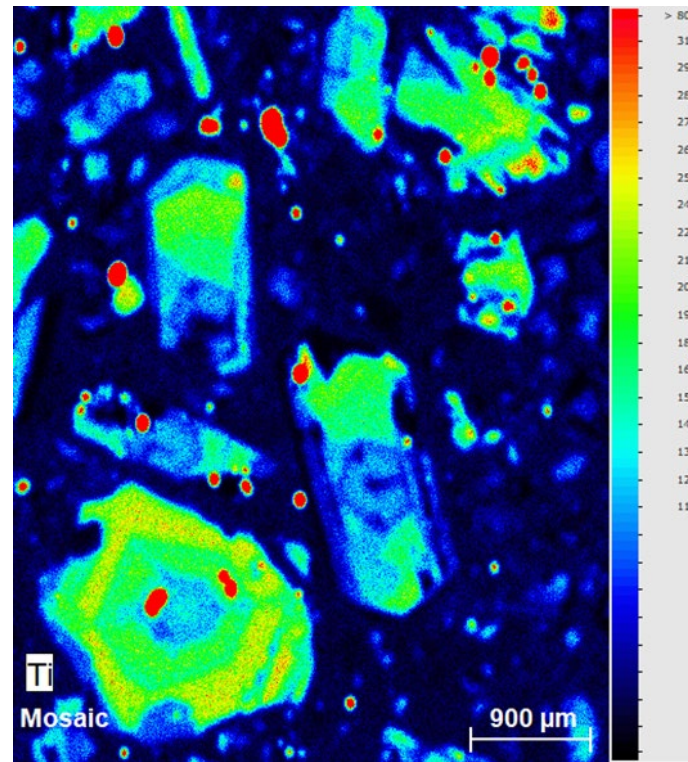

Micro-XRF - Iron

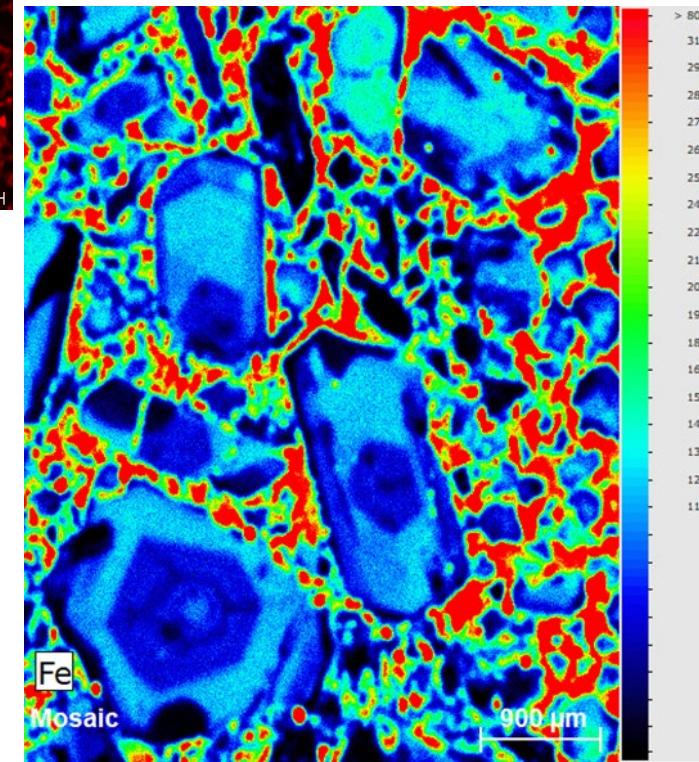

Sapphires:

Results: Micro-XRF and OM-CL - Böhmite-alunite-sapphire metasomatite

Optical microscope

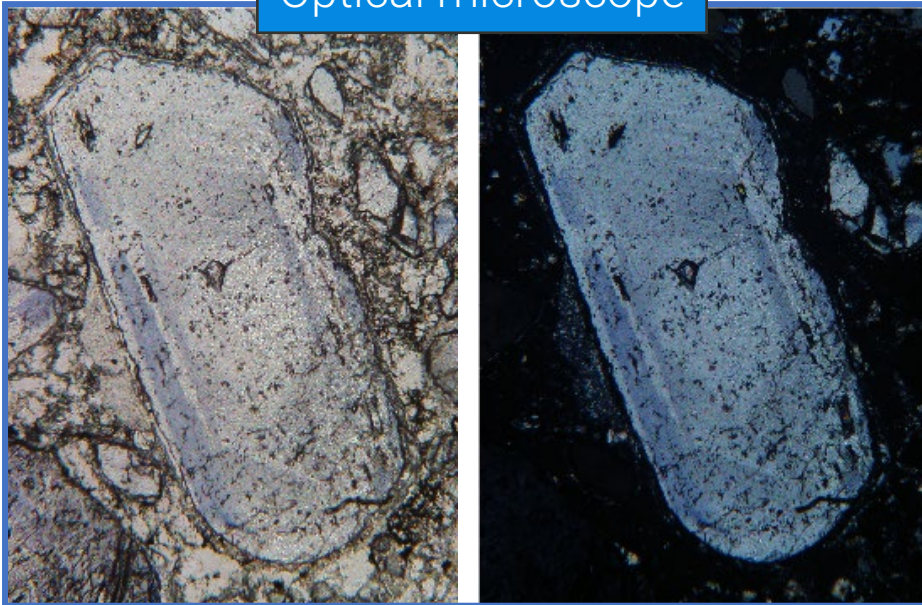

OM-CL

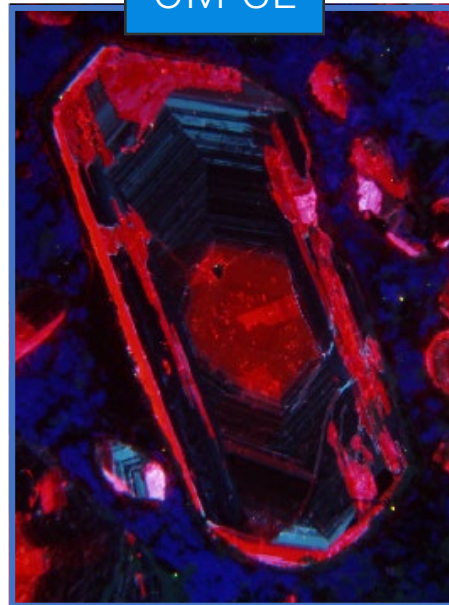

Micro-XRF - Elemental Distribution Maps

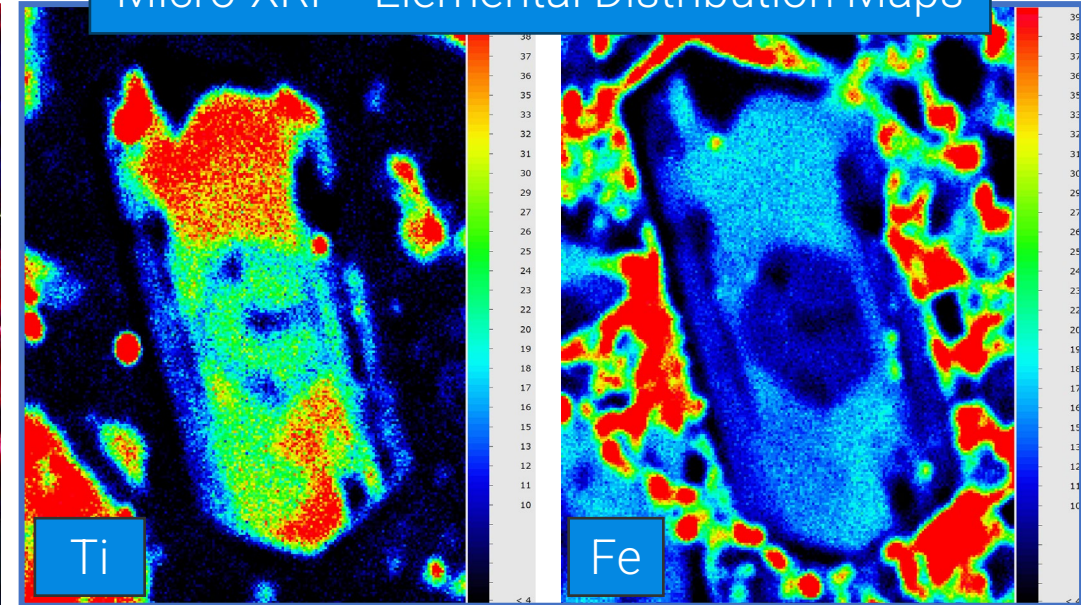

Sapphires:

Results: SEM-EDS – Böhmite-alunite-sapphire metasomatite

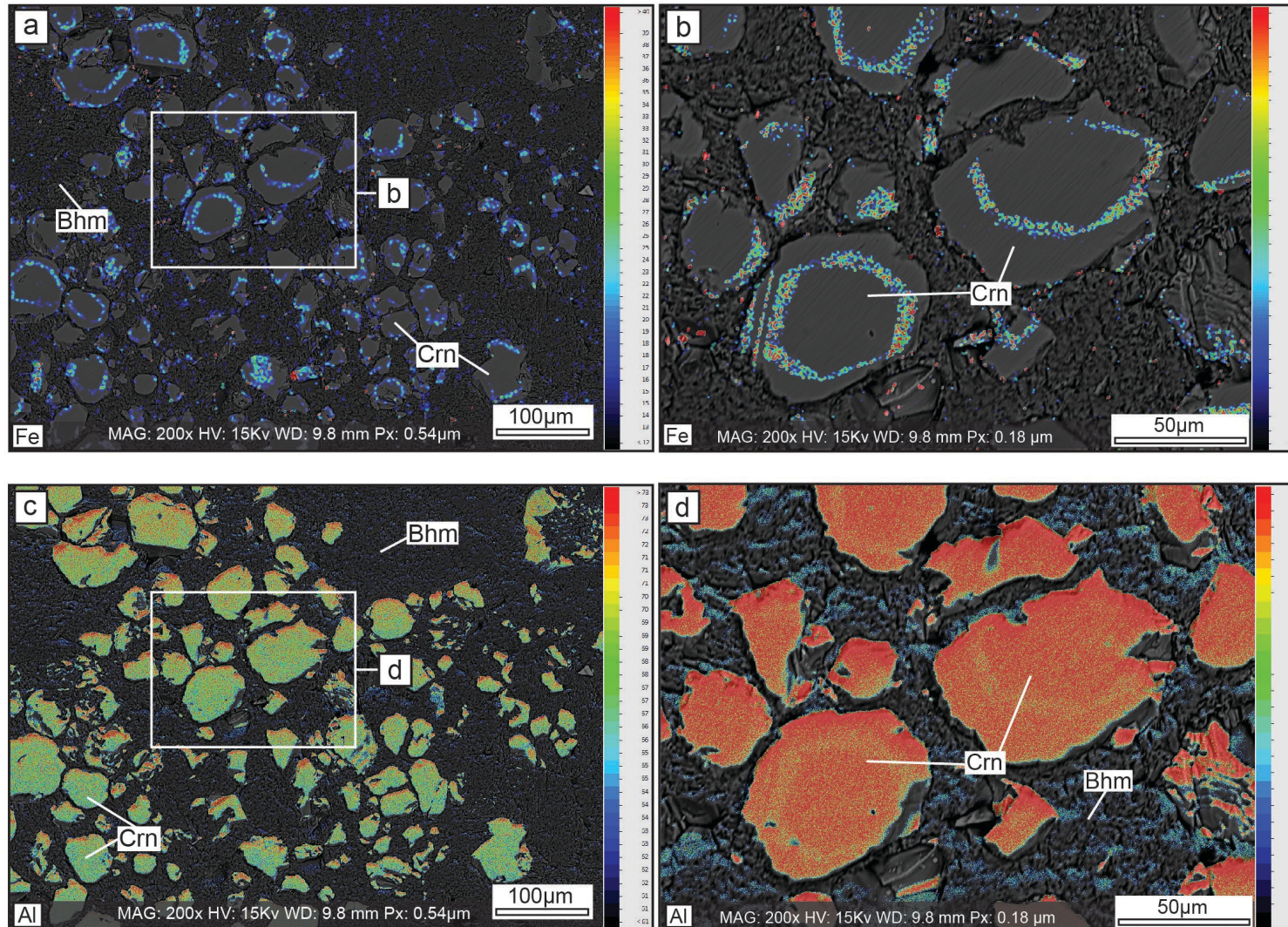

SEM-EDS Hypermap Data:

SEM-EDS of Fe **(a-b)** and Al **(c-d)** of zoned sapphire crystals. It should be noted that the increase in iron intensity is at the expense of aluminium intensity, so that can be related to the exchange of elements that produce the colour.

Sapphires:

Results: Diaspore-dravite-sapphire metasomatite

(a) Sapphire-diaspore-dravite metasomatite hand sample.

(b) Fibrous diaspore and anhedral dravite (Binocular lens).

(c-f) Subhedral fibrous diaspore, poikilitic anhedral sapphire and zoned granoblastic dravite (cross-polarized light and plane polarized light).

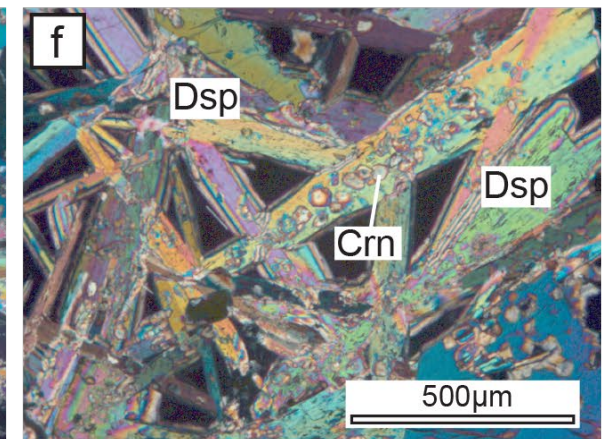
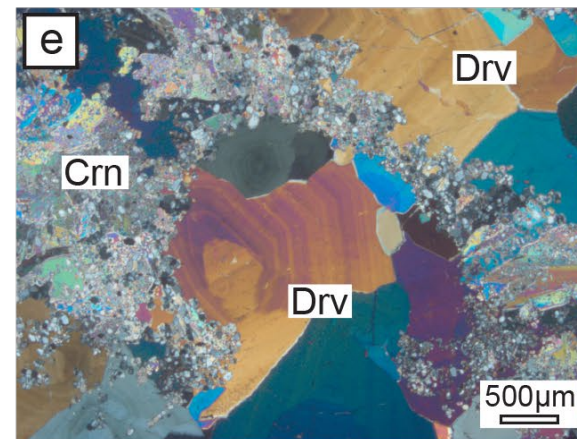
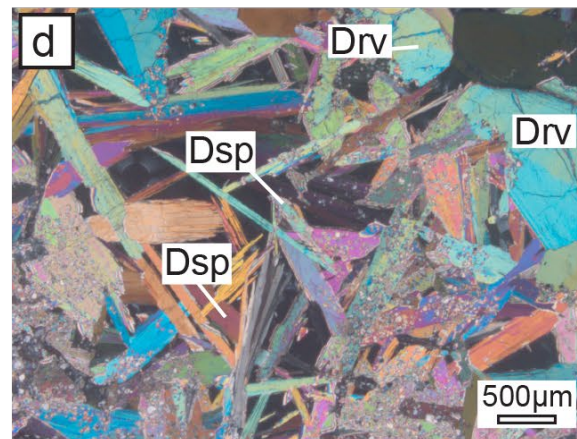
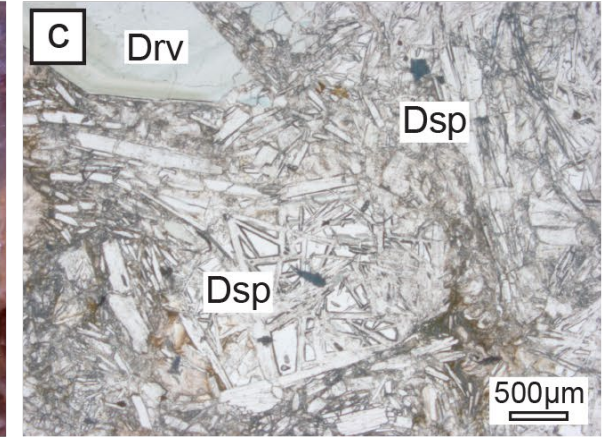
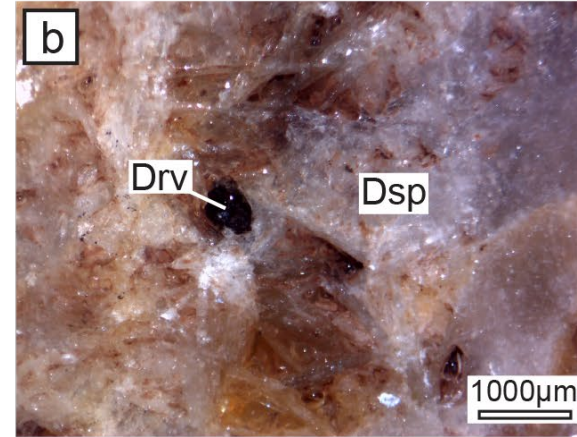
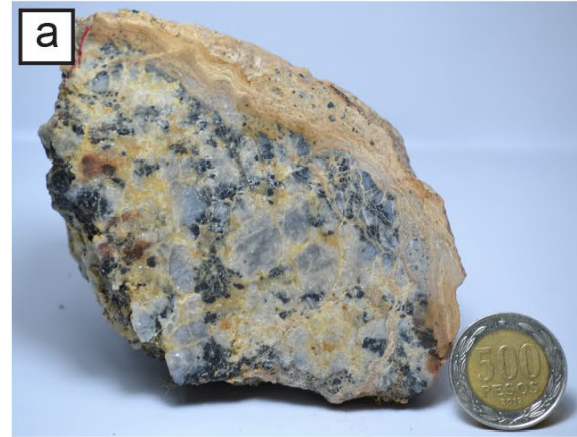

Sapphires:

Results: Micro-XRF – Diaspore-dravite-sapphire metasomatite

Optical

Optical

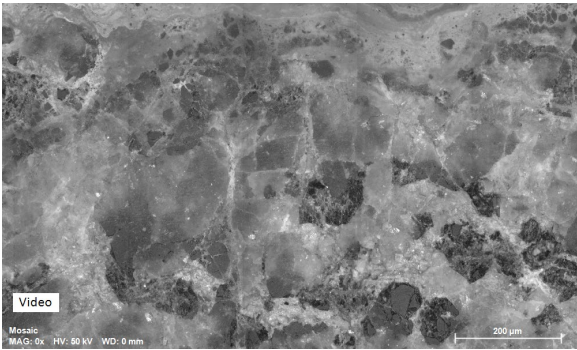

Mg

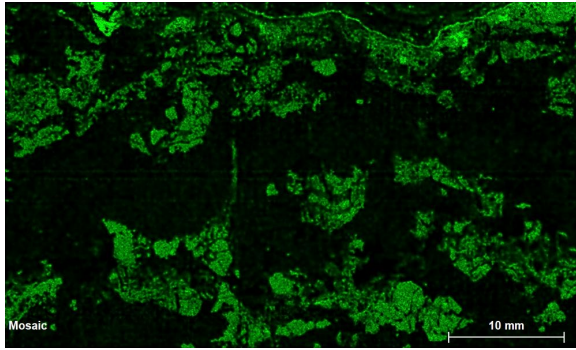

Ti

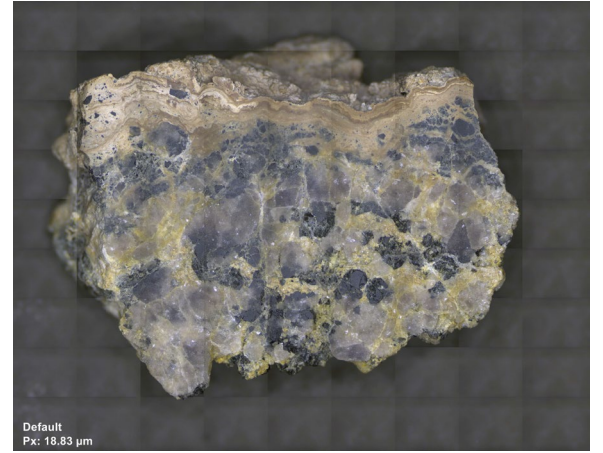
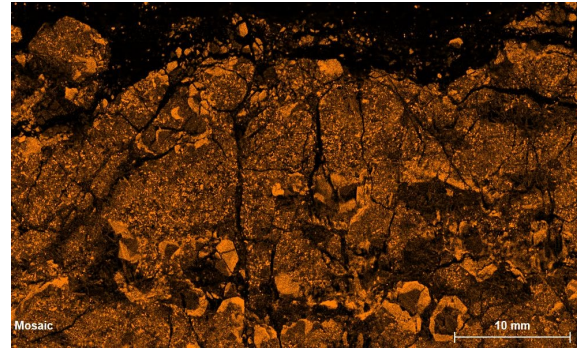

Al

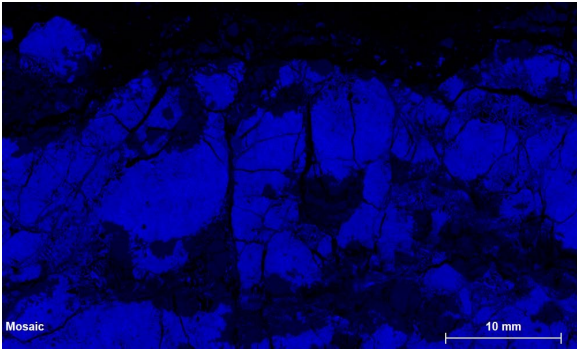

Ca

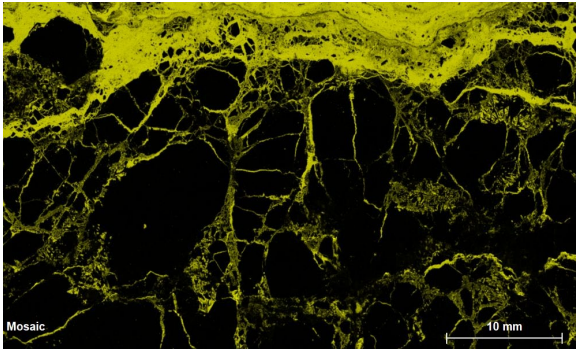

Si

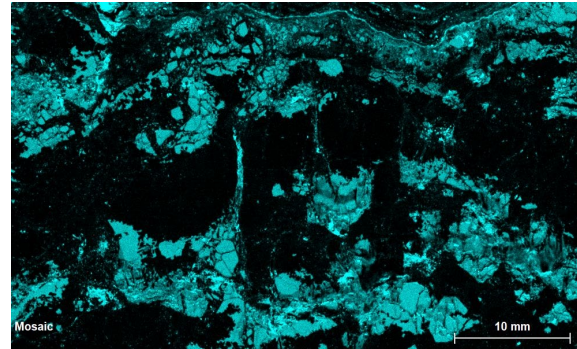

Fe

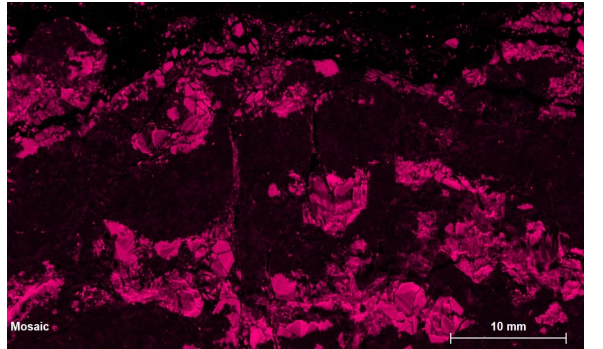

Sapphires:

Results: SEM-EDS – Diaspore-dravite-sapphire metasomatite

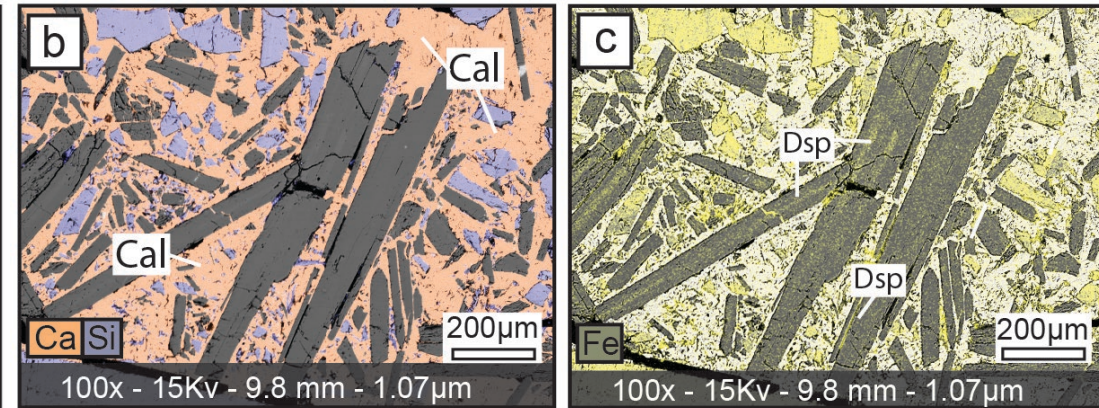
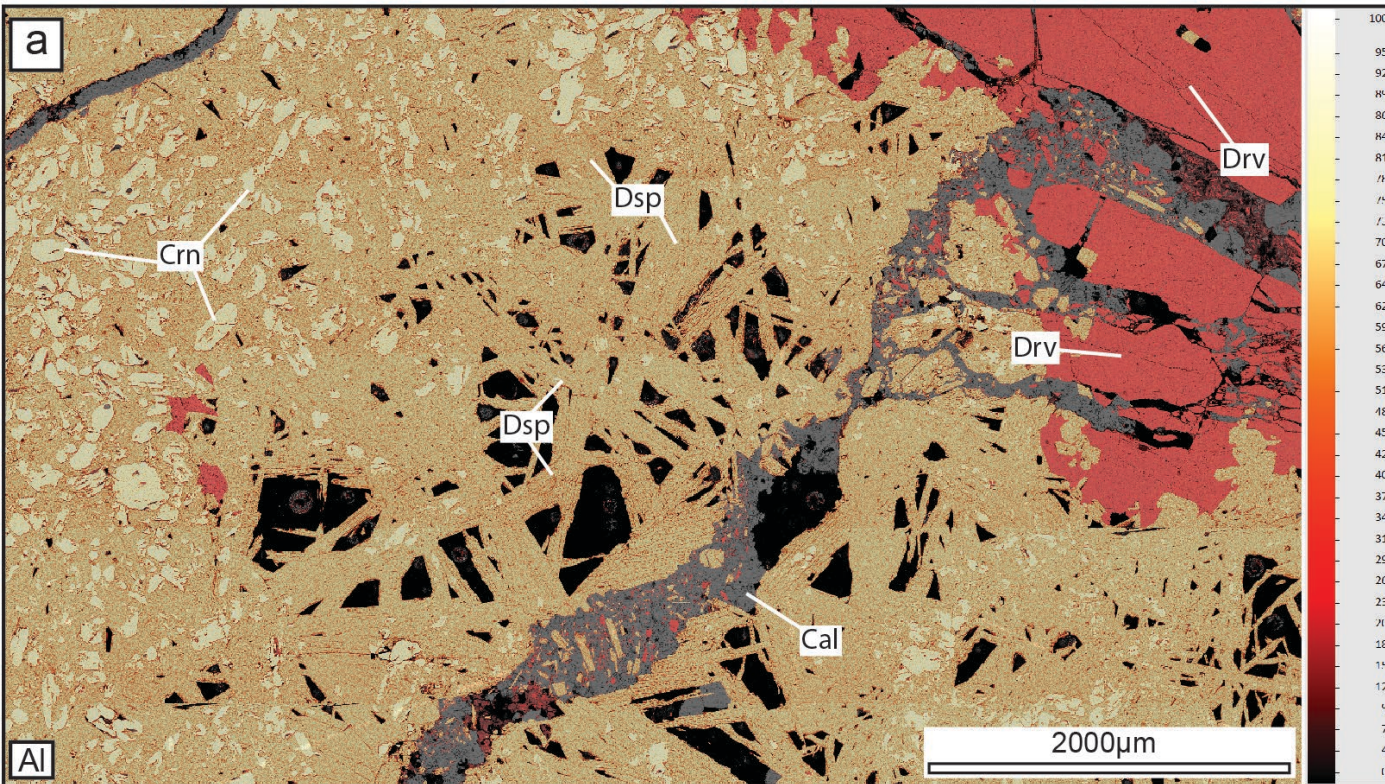

SEM-EDS Hypermap Data:

(a) Percentage intensity elemental distribution map of Al, wherein an intense diaspore replacement on sapphire edges and calcite fills an intense fracture network that cuts both the sapphire-diaspore association and dravite.

(b-c) Intensity elemental distribution maps of Ca, Si and Fe in selected zones are consistent with diaspore, dravite, and calcite distribution.

Sapphires:

Results: Dravite-sapphire metasomatite

(a) Dravite-sapphire metasomatite hand sample.

(b) Euhedral multicolor sapphire and subhedral dravite (Binocular lens).

(c) Corroded euhedral sapphire crystal with blue pleochroism and zoned green dravite (plane-polarized light).

(d-f) Corroded euhedral sapphire crystal and granoblastic dravite (cross-polarized light).

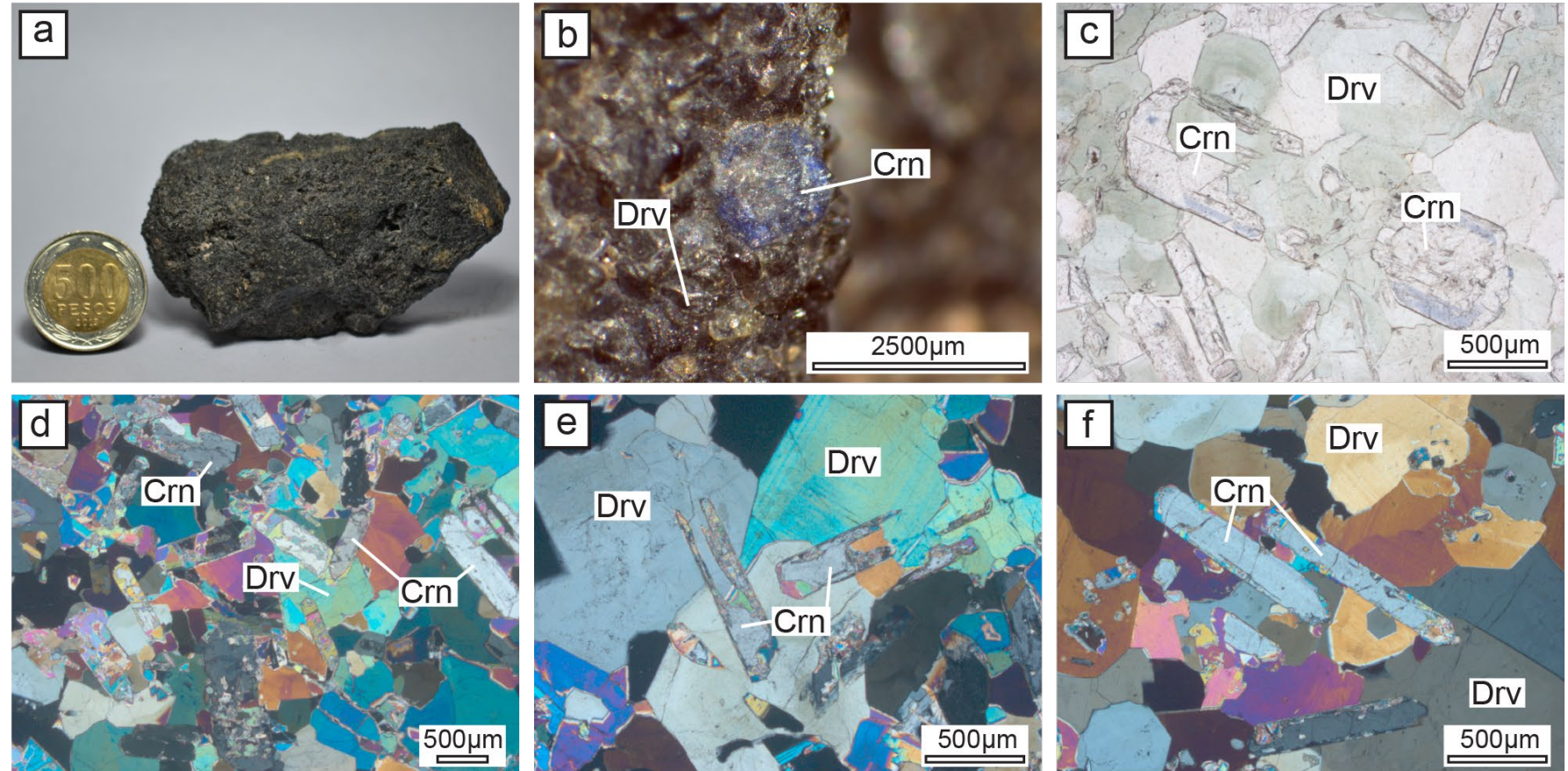

Sapphires:

Results: SEM-EDS – Dravite-sapphire metasomatite

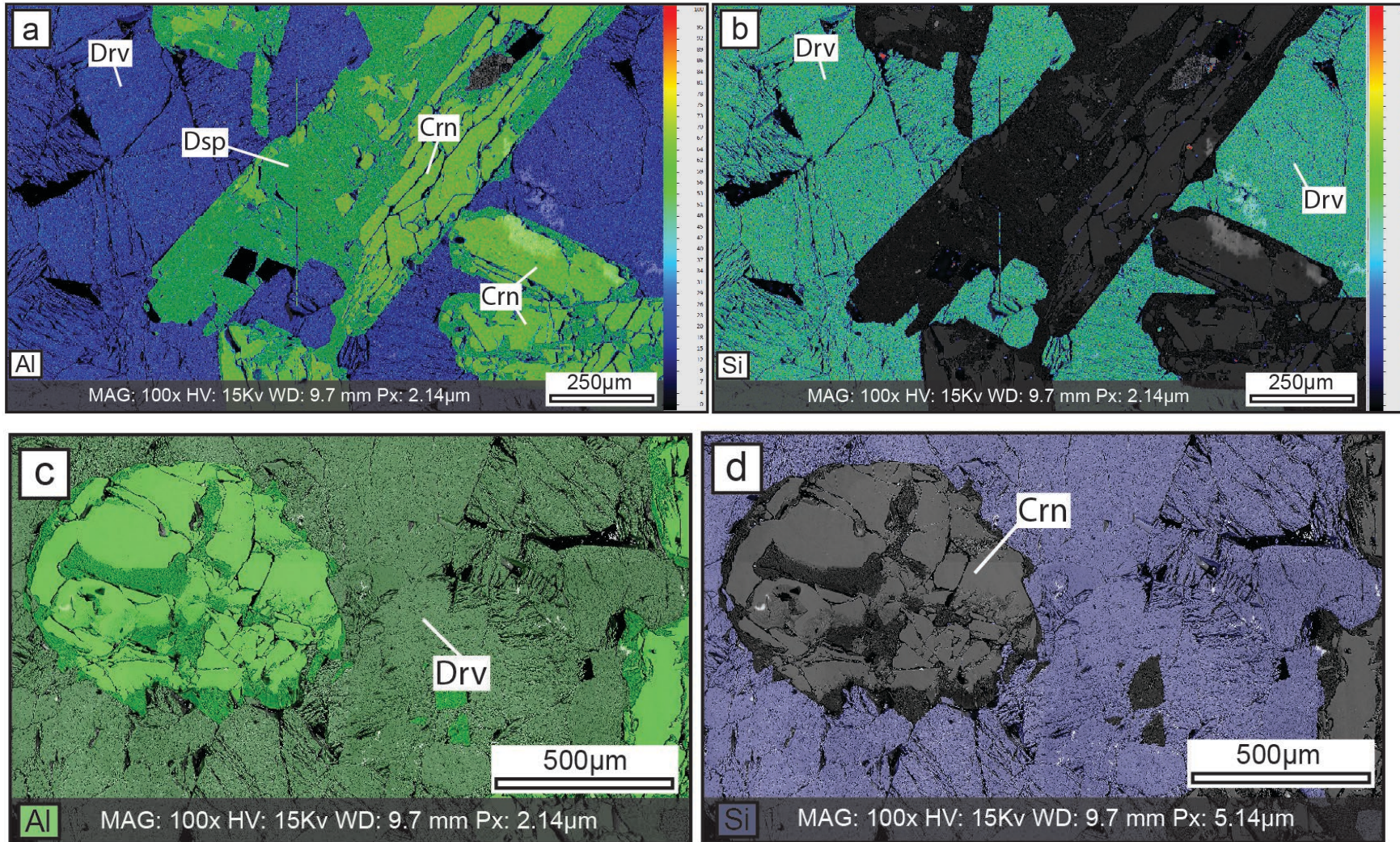

SEM-EDS Hypermap Data:

(a-b) Percentage intensity elemental distribution maps of Al and Si are consistent with an alteration of sapphire to diaspore and the presence of dravite.

(c-d) Intensity elemental distribution maps of Si and Al are consistent with the occurrence of mineral phases.

Sapphires: Results: Micro-XRF (M4 Tornado)

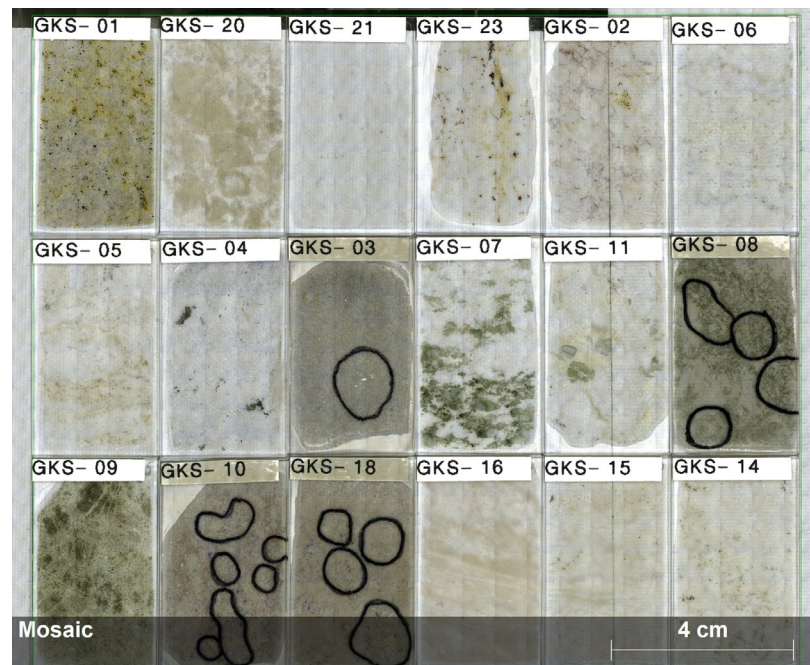

Analysis of 18 Thin Sections that represent the various lithologies observed at Portezuelo de Pajas Blancas.

Above: Optical Image
Right: Overlaid Element Intensity Maps

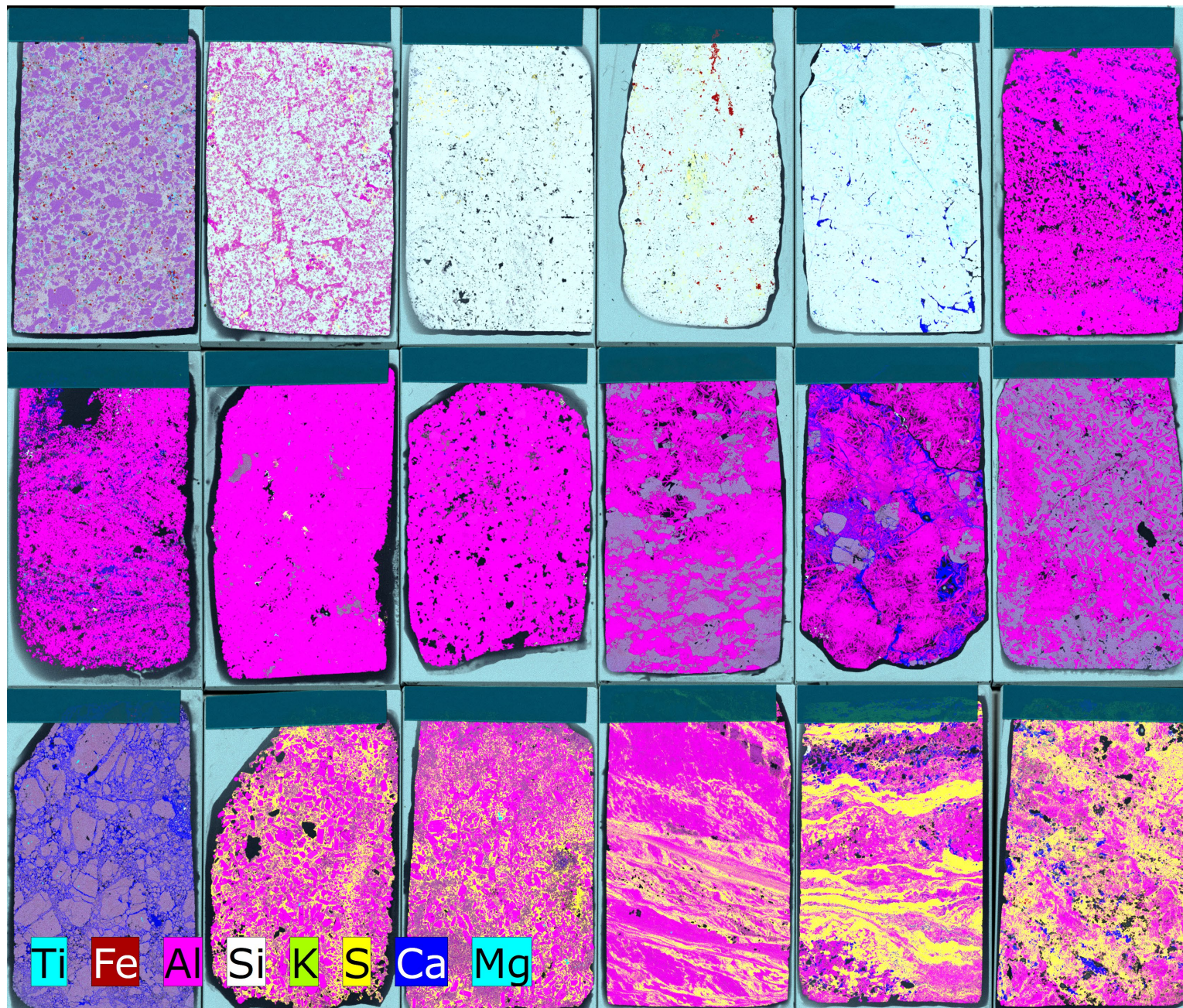

Sapphires:

Results: Micro-XRF (M4 Tornado)

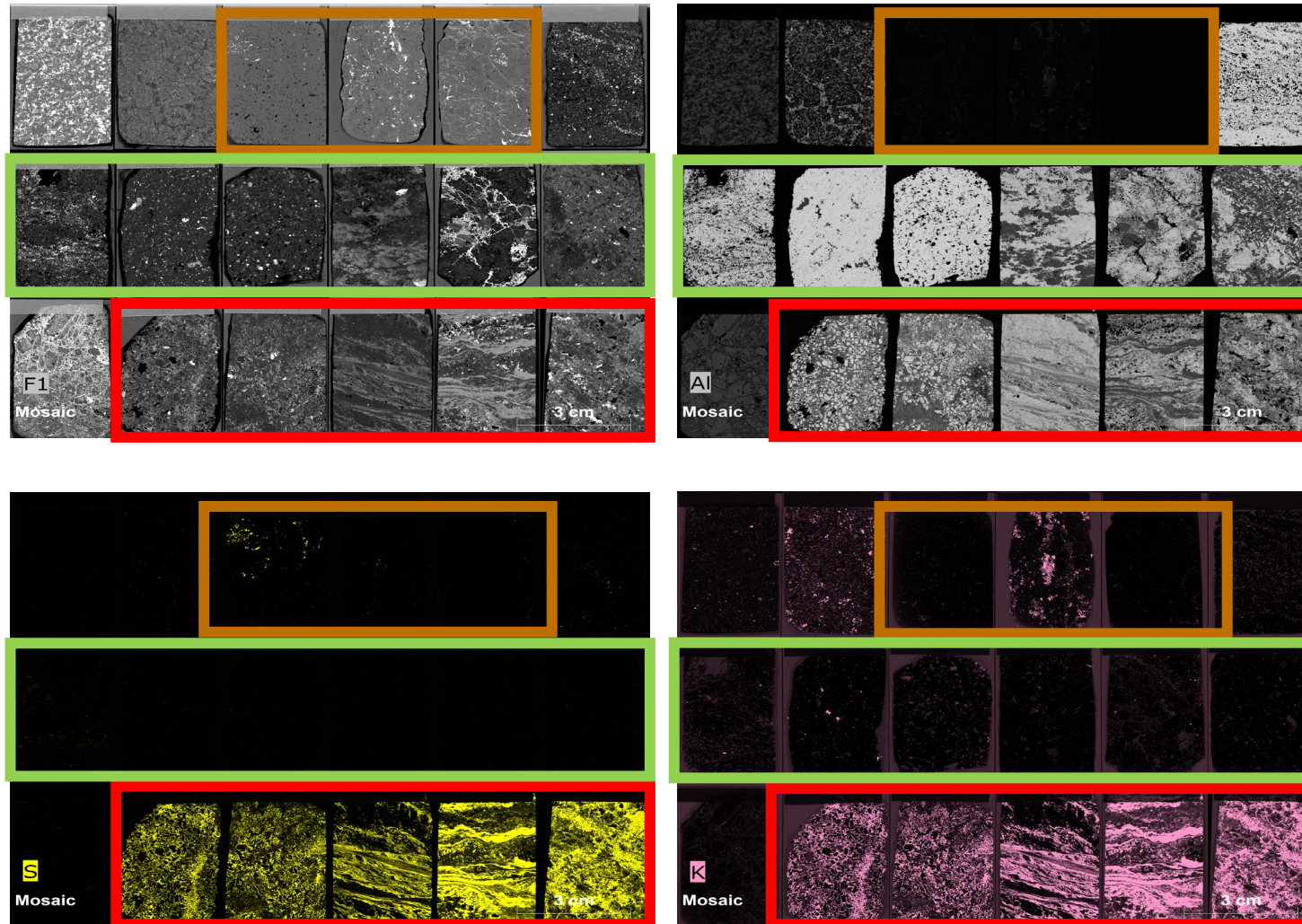

Analysis of 18 Thin Sections that represent the various lithologies observed at Portezuelo de Pajas Blancas. Individual Element Intensity Maps.

Top Left: Total X-ray Intensity (Grey)
 Bottom Left: S Intensity
 Top Right: Al Intensity
 Bottom Right: K Intensity

- The main Sapphire bearing units are dominated by Al.
- The presence of sulphur and potassium is related to Alunite
 $KAl_3(SO_4)_2(OH)_6$ (Alteration)
- Quartzite and Hydrothermal breccia

Part 3: Sapphires from Portezuelo de Pajas Blancas Placer, northern Chile.

Primary growth textures and secondary alteration features

Sapphires:

Results: Placer Sapphires Samples

- Optical images of sapphires from the Portezuelo de Pajas Blancas placer deposits.
- The crystals are a representative selection from a total of 600 crystals.
- The sapphires are divided by their colour and colour distribution.

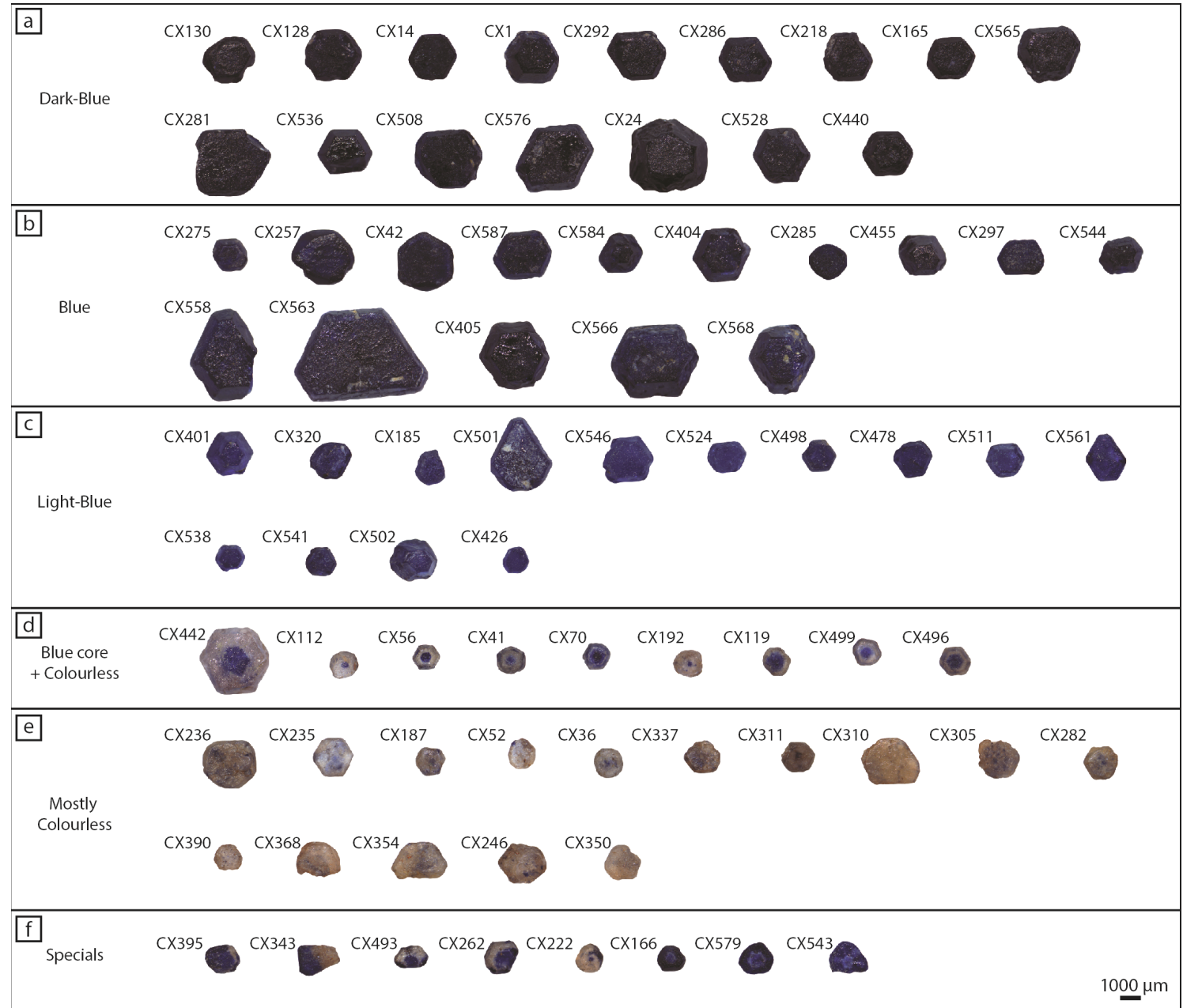

Sapphires:

Results: Placer Sapphires Samples

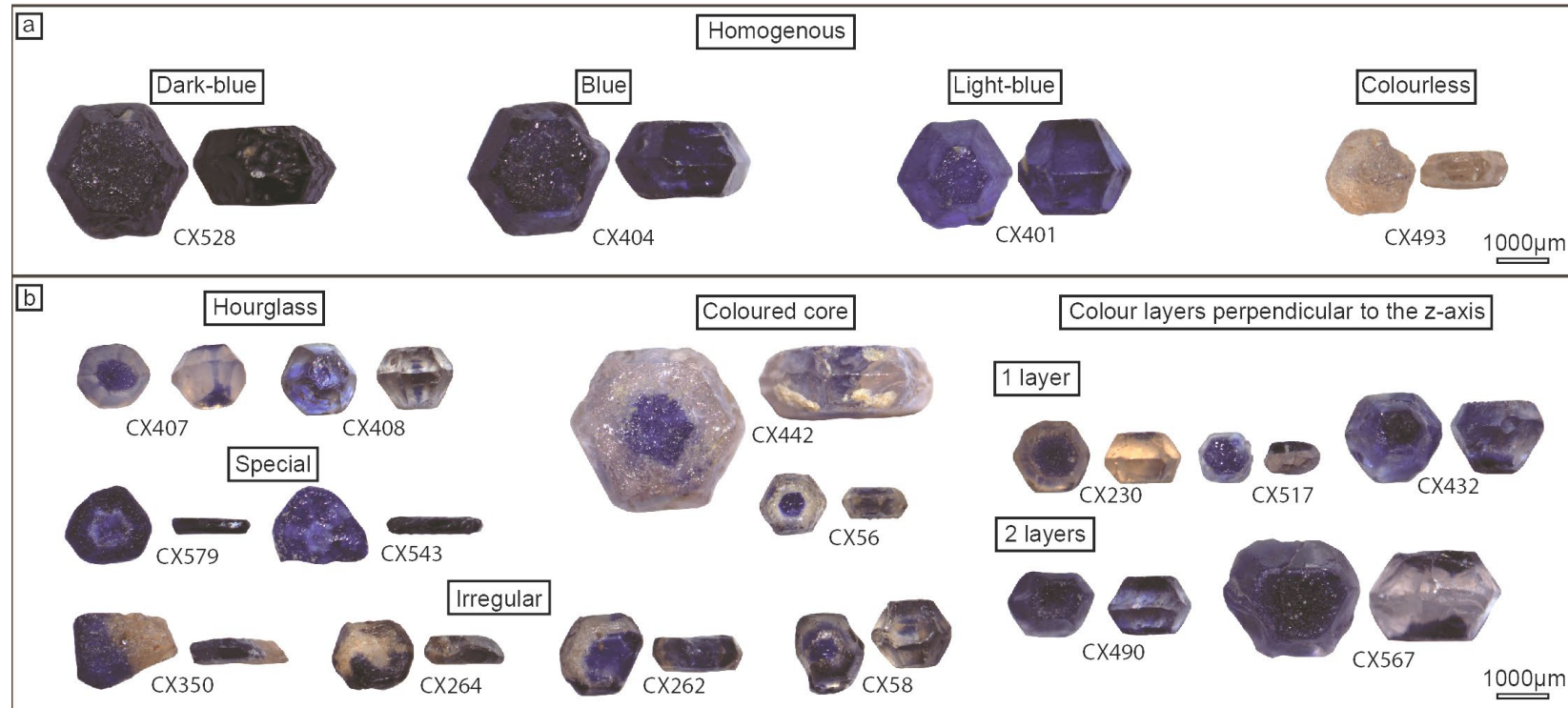

- Sapphires characterisation from Portezuelo de Pajas Blancas placer deposit by colours and colours distribution.
- **(a)** The sapphires display dark-blue, blue, light-blue and colourless colours.
- **(b)** Sapphires Colour distribution shows hourglass, colour core, colour layers, specials and irregular types. The sapphires are shown in transversal and longitudinal sections relative to the z-axis.

Sapphires:

Results: Micro-XRF, SEM-CL

Optical Microscope

SEM-CL

Micro-XRF (Ti)

Micro-XRF (Fe)

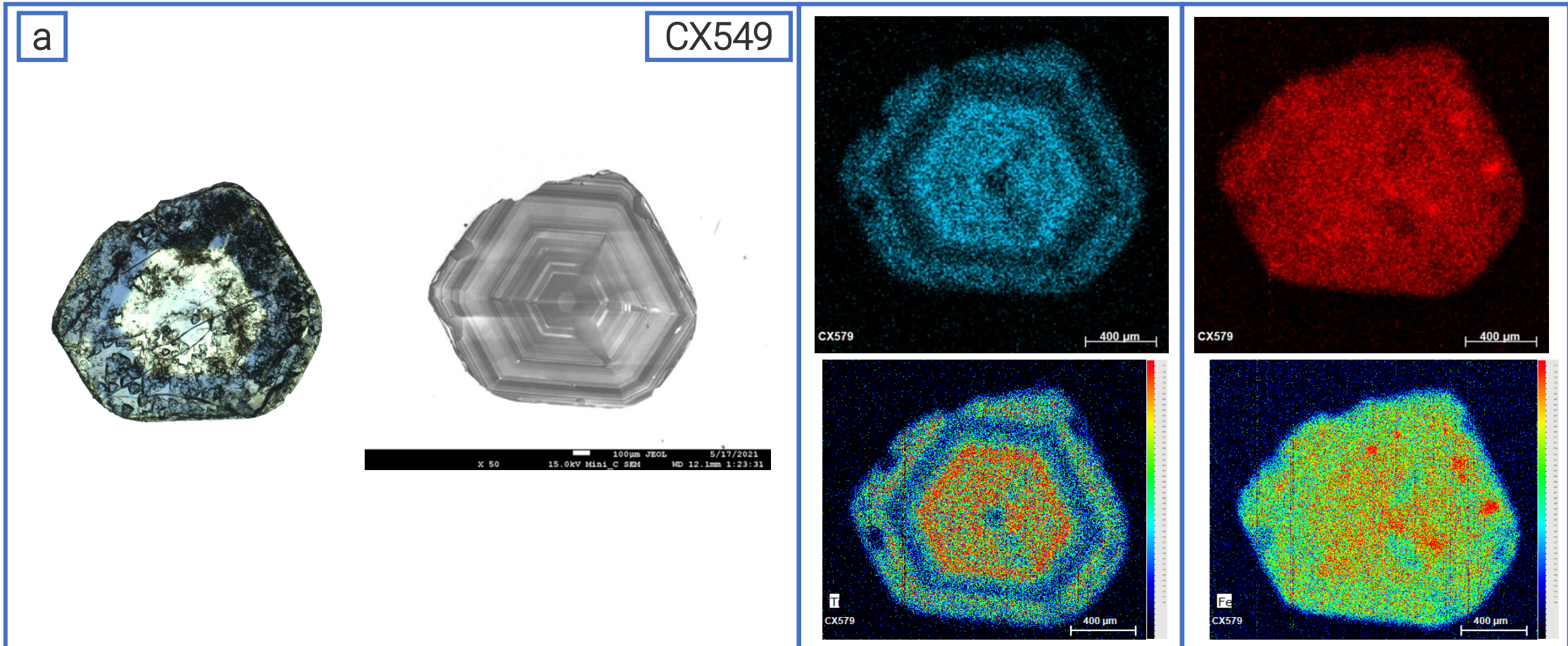

Sapphires:

Results: Micro-XRF, SEM-CL

Optical Microscope

SEM-CL

Micro-XRF (Ti)

Micro-XRF (Fe)

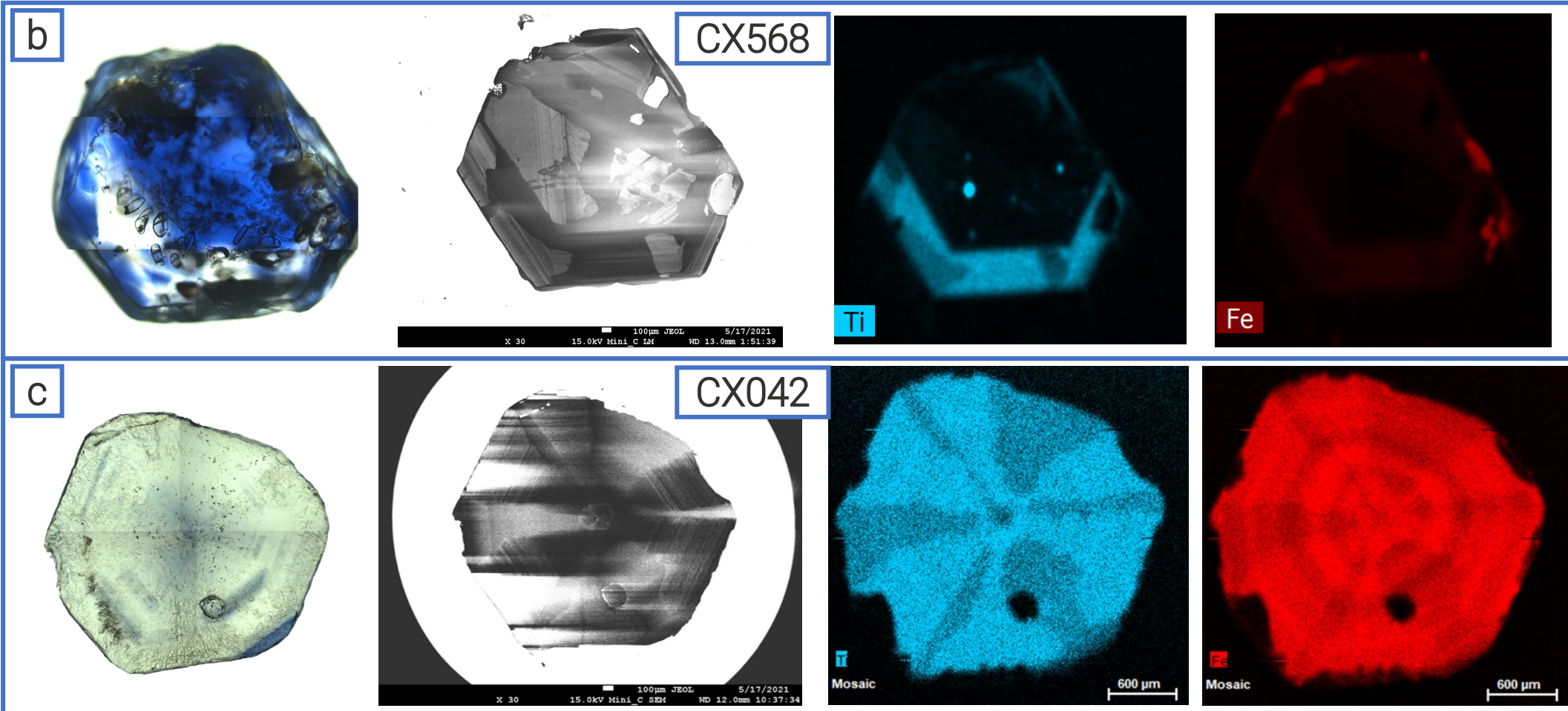

Sapphires:

Results: Micro-XRF, SEM-CL

Optical Microscope

SEM-CL

Micro-XRF (Ti)

Micro-XRF (Fe)

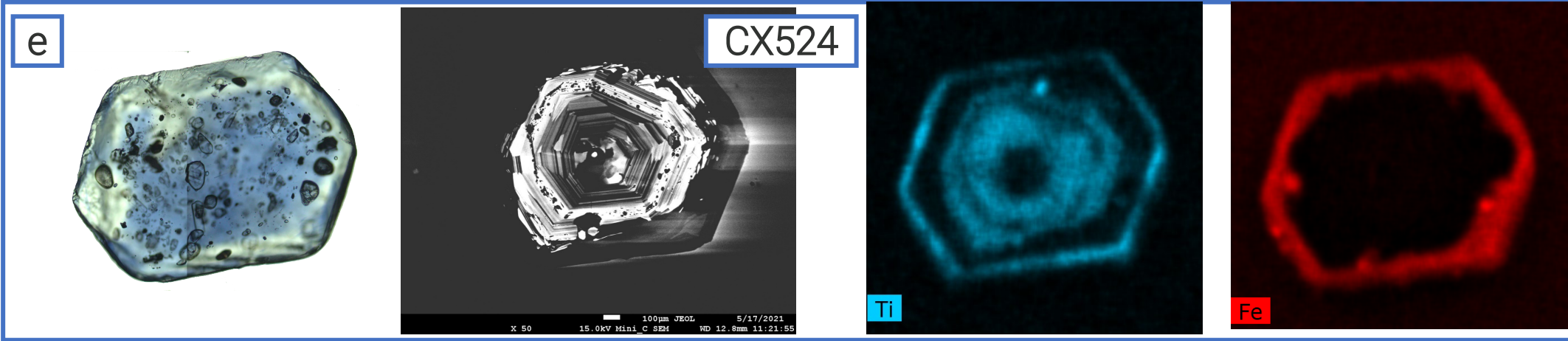
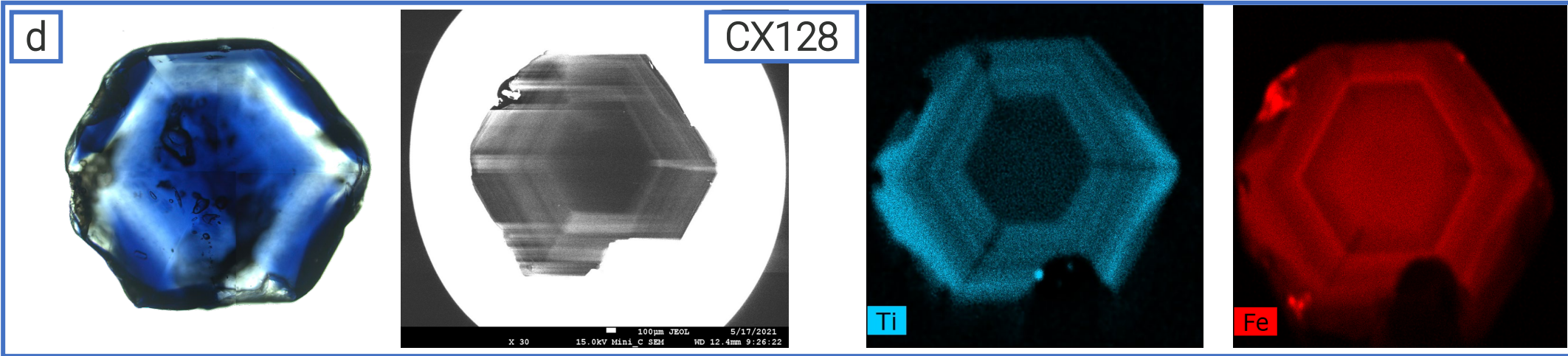

Sapphires:

Results: Micro-XRF, SEM-CL

Optical Microscope

SEM-CL

Micro-XRF (Ti)

Micro-XRF (Fe)

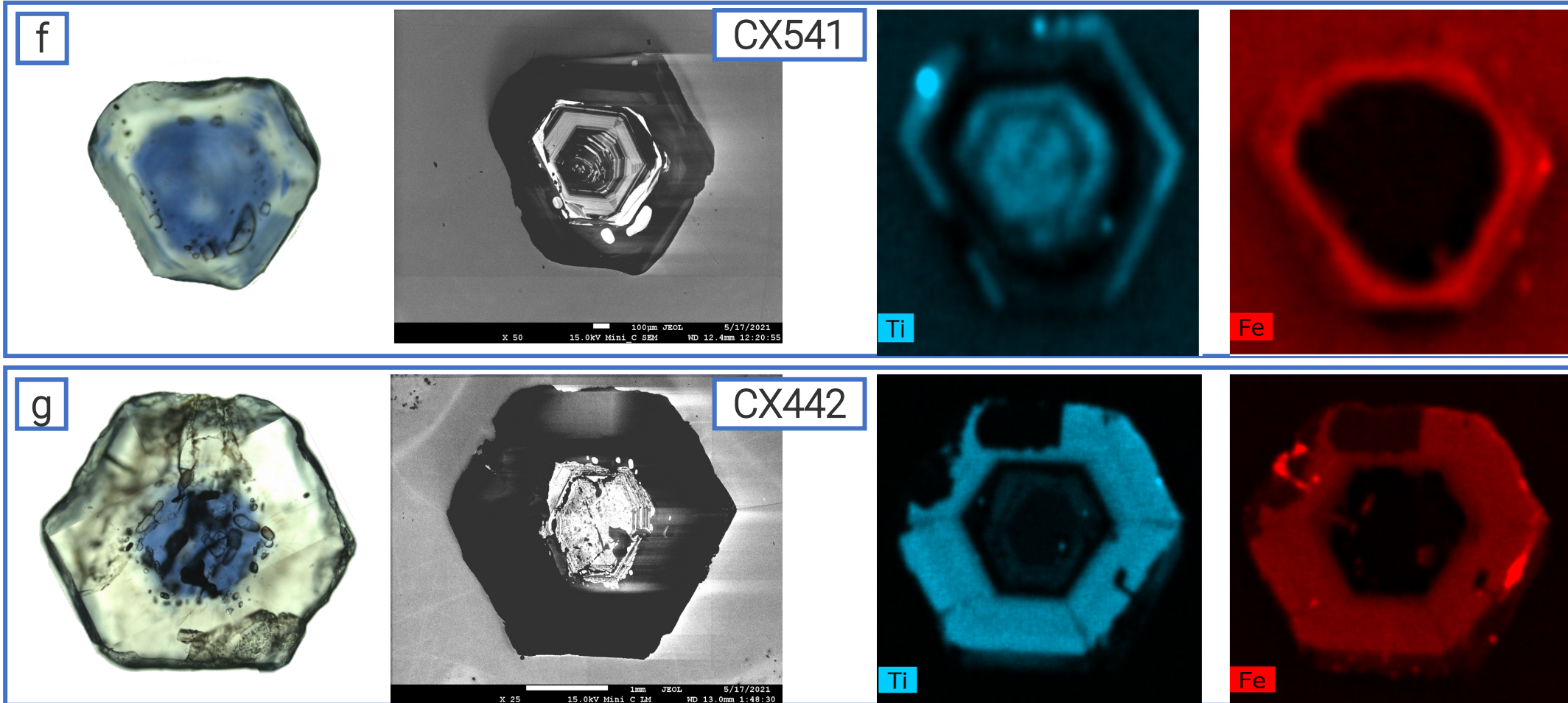

Sapphires:

Results: Micro-XRF, SEM-CL

Optical Microscope

SEM-CL

Micro-XRF (Ti)

Micro-XRF (Fe)

Micro-XRF (Cr)

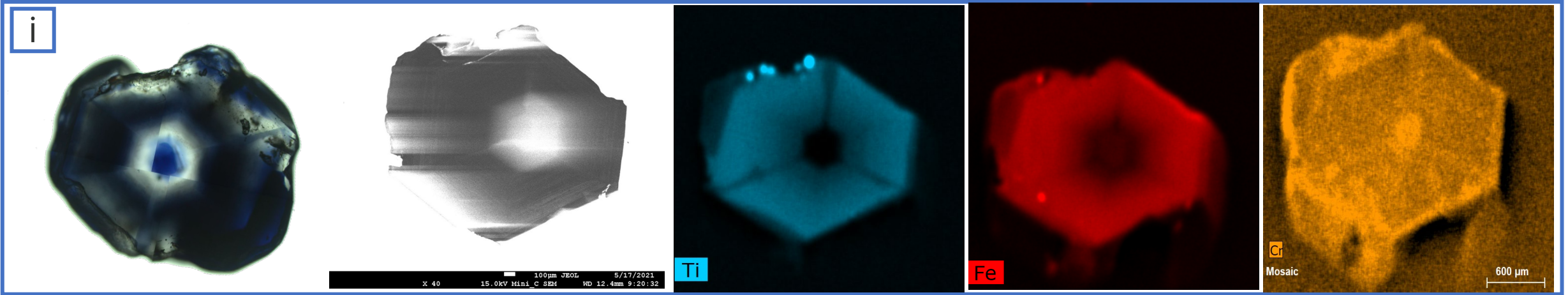
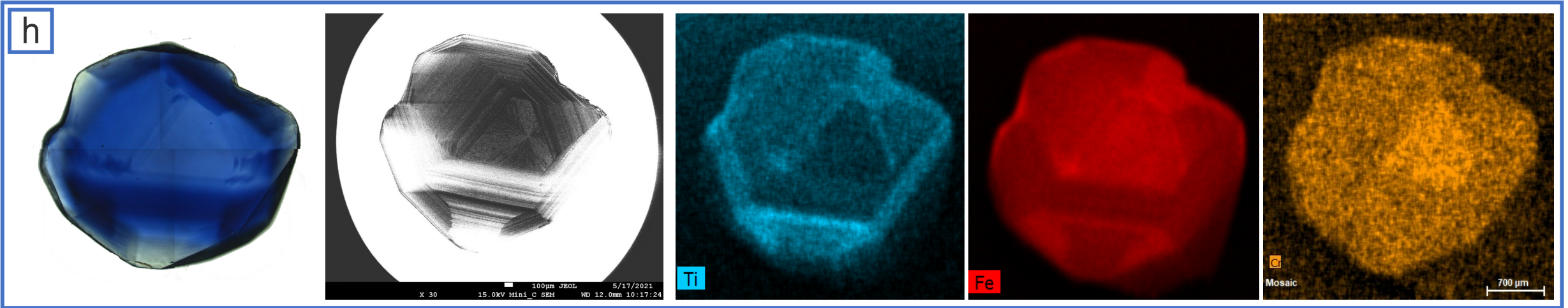

Part 4: Sapphires from Portezuelo de Pajas Blancas Placer, northern Chile.

Fluid and Solid Inclusions

Sapphires:

Results: Mineral Inclusion (Andalusite) - μ XRF

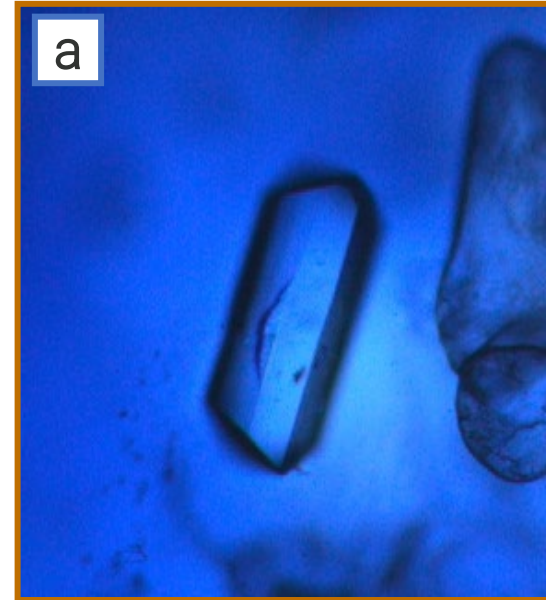
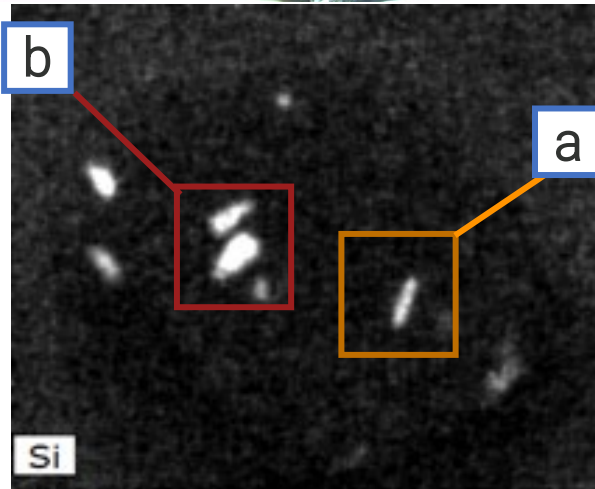
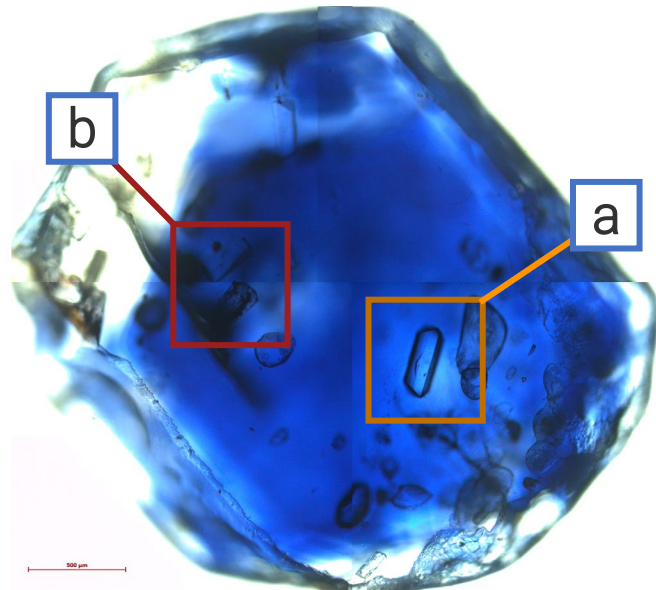

position from the surface:
• **Depth: 0-100 μ m**

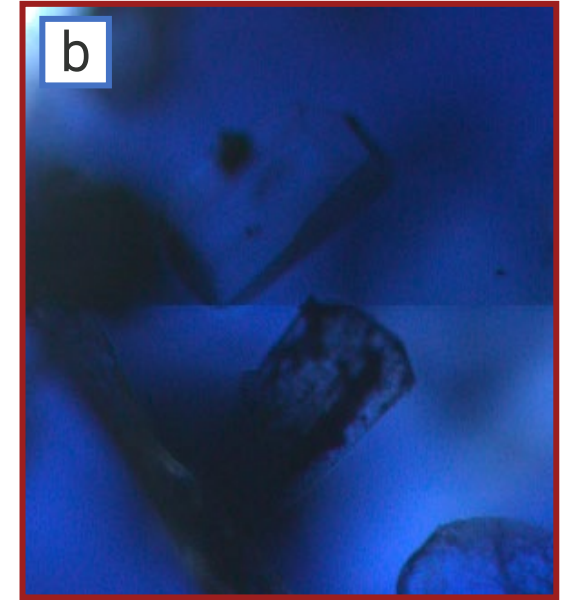

position from the surface:
• **Depth: 25-70 μ m**

Sapphires:

Results: Fluid and Mineral Inclusions - μ XRF

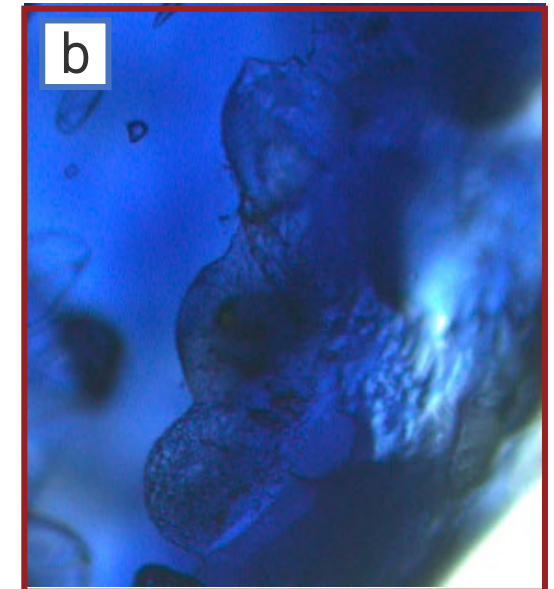
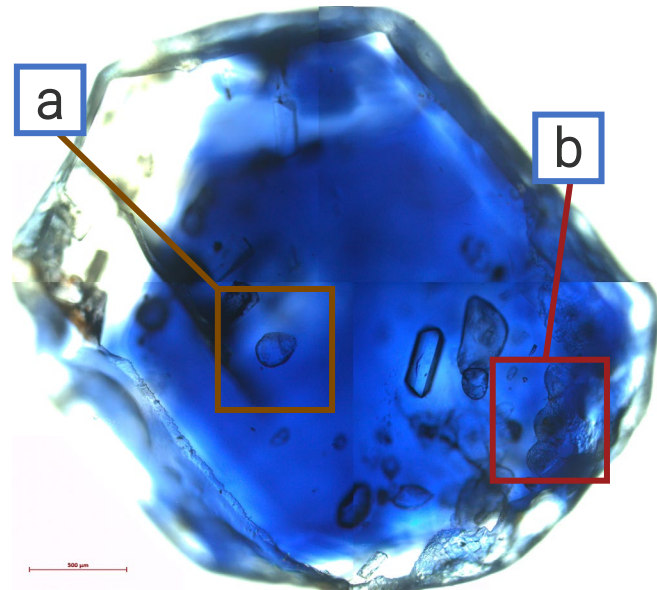

position from the surface:

- **Depth: 0-35 μ m**

position from the surface:

- **Depth: 0-30 μ m**

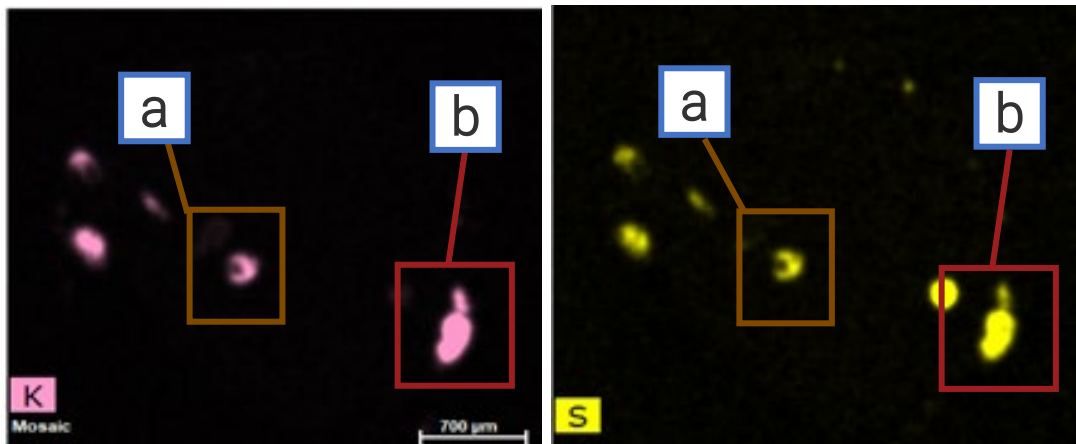

Sapphires:

Results: Fluid and Mineral Inclusions - μ XRF

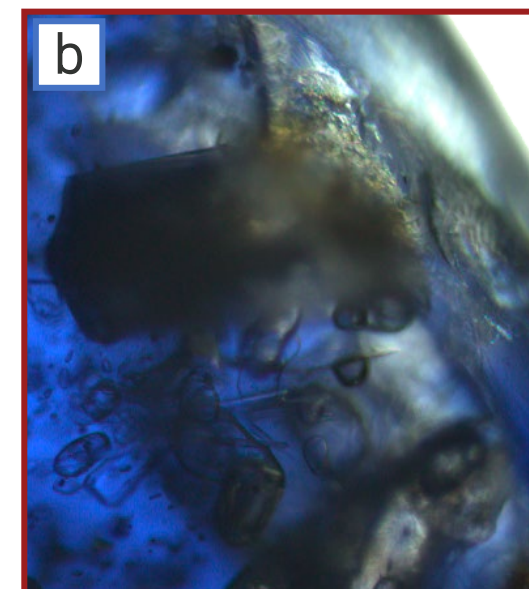
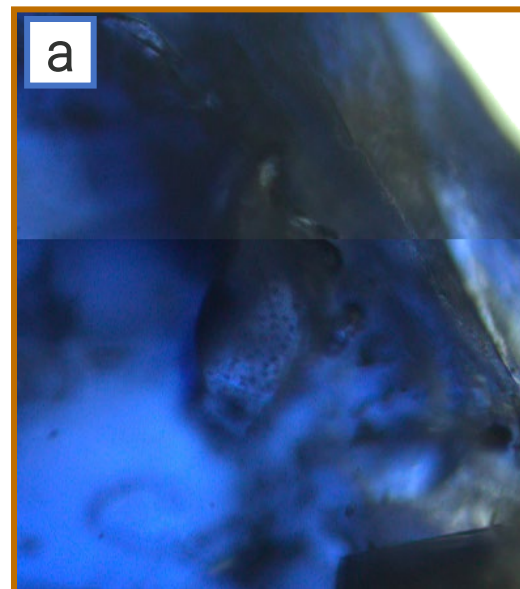
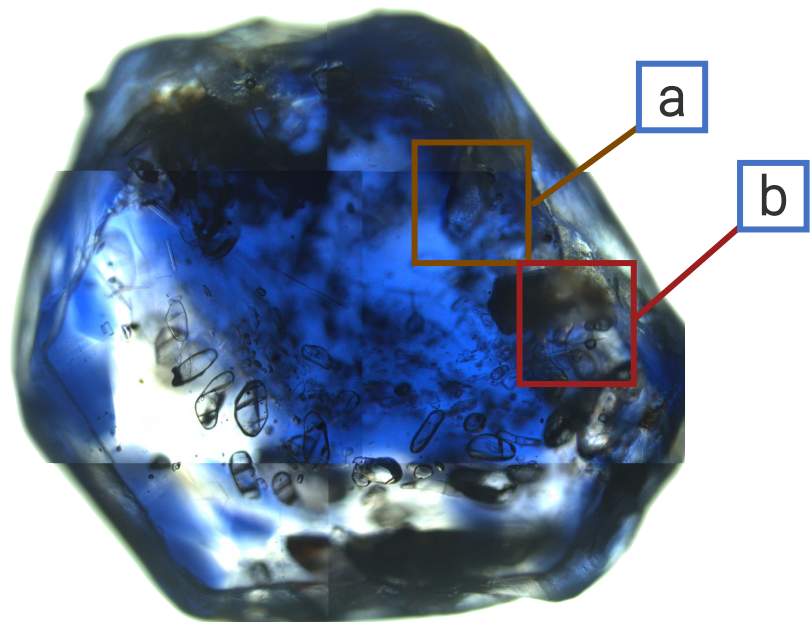

position from the surface:
• **Depth: 0-80 μ m**

position from the surface:
• **Depth: 70-100 μ m**

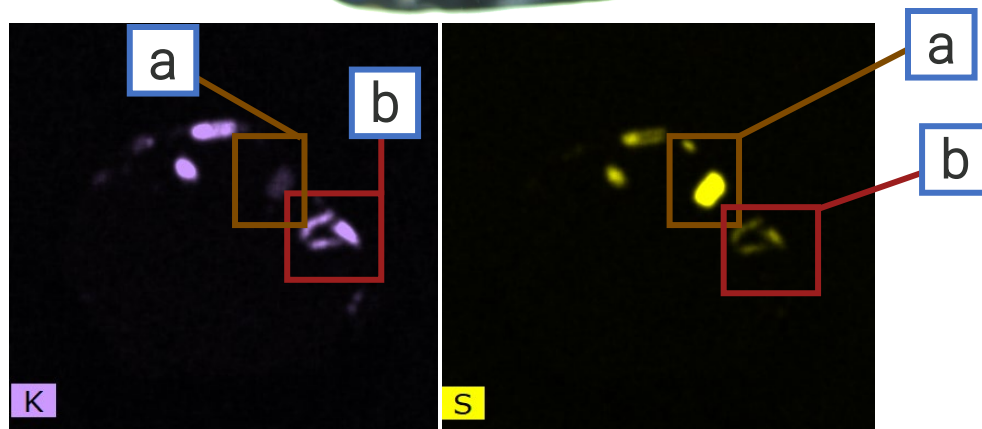

Sapphires: Chile - Portezuelo de Pajas Blancas – Genetic Model

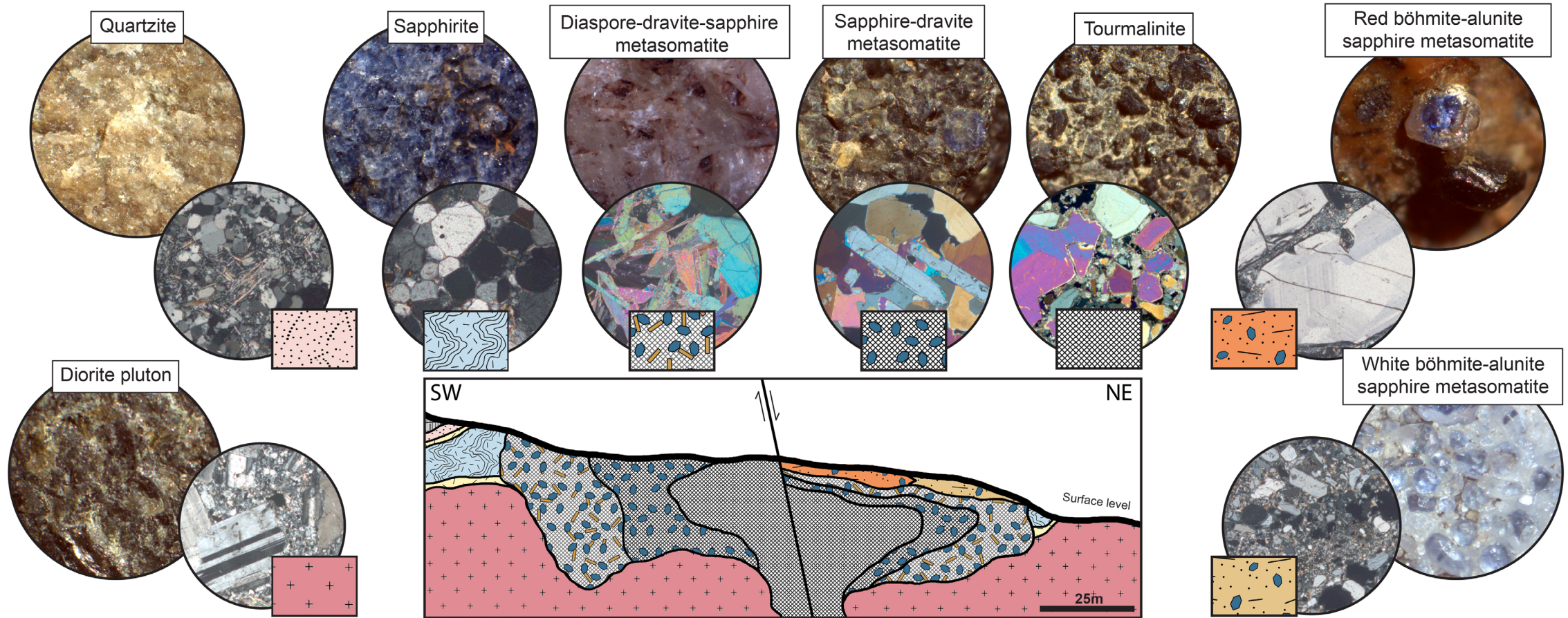

Paper: Submitted to Ore Geology Review

Summary and Conclusions:

Why use multiple techniques

- Understanding the composition of Sapphires is important to determine their gem quality, for example colour and inclusions.
- In addition, a combination of micro-XRF and SEM-EDS amongst other techniques such as SEM-CL, OM-CL and optical microscopy will expand your workflow analytical capabilities.
- Micro-XRF is ideal to analyze large areas at the micrometer scale and is a powerful tool for identifying both trace elements or minerals.
- In contrast, SEM analysis allows a higher spatial resolution required to understand the elemental and mineralogical processes at a high resolution.
- The benefits and capabilities of each ultimately provide the best workflow for such projects.

Sapphires: Acknowledgments



Gustavo Miranda-Díaz,
Dipl. -Geol. PhD Candidate
Freiberg University of Mining
and Technology, Freiberg,
Germany

Paper: Submitted to Ore Geology Review

This project is supported by German Academic Exchange Service (DAAD), Freiberg University of Mining and Technology, Universidad de Atacama.



TECHNISCHE UNIVERSITÄT
BERGAKADEMIE FREIBERG

Die Ressourcenuniversität. Seit 1765.

DAAD

Deutscher Akademischer Austauschdienst
German Academic Exchange Service



UNIVERSIDAD
DE ATACAMA

Thank you for your time.

Any Question?

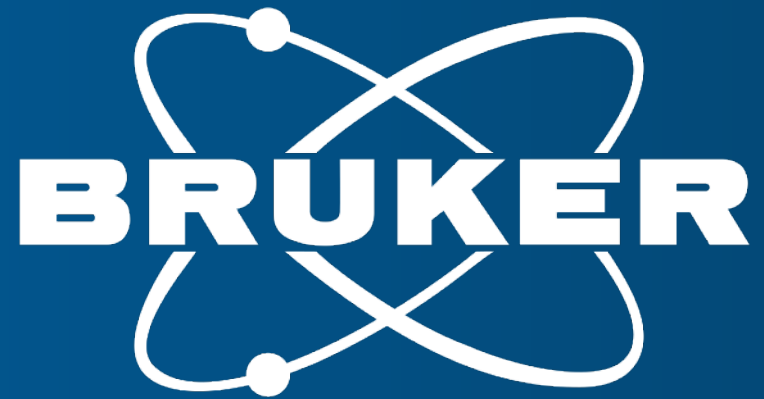

Innovation with Integrity