

Standard-Bore & Ultra-High Field DNP

Making the Invisible Visible

DNP is microwave irradiation that transfers the 660x higher polarization of native or admixed electron spins to ¹H and other nuclei in the solvent matrix and sample.

- Bruker DNP systems enable solid-state NMR with unsurpassed sensitivity gains (e.g., >200x on standard samples at 400 MHz)
- As well as excellent cooling and MAS performance (ca. 95 K at max spinning rates of 14 – 65 kHz for 3.2 to 0.7 mm probes),
- And stability to enable even the most-demanding experiments (up to 14-days continuously running).

The full Bruker package allows exciting new applications in biological solids, materials science, and pharmaceuticals.

Gyrotron- & Klystron-based DNP Systems

59 systems since 2008 Installed or underway

32x 400 MHz (263 GHz)	7x 800 MHz (527 GHz)
19x 600 MHz (395 GHz)	1x 900 MHz (593 GHz)

Gyrotrons (for 400 – 900 MHz NMR) with CPI Palo Alto

- 10 – 30 W output
- Cryofree magnet
- stable operation
- up to 10 yr lifetime

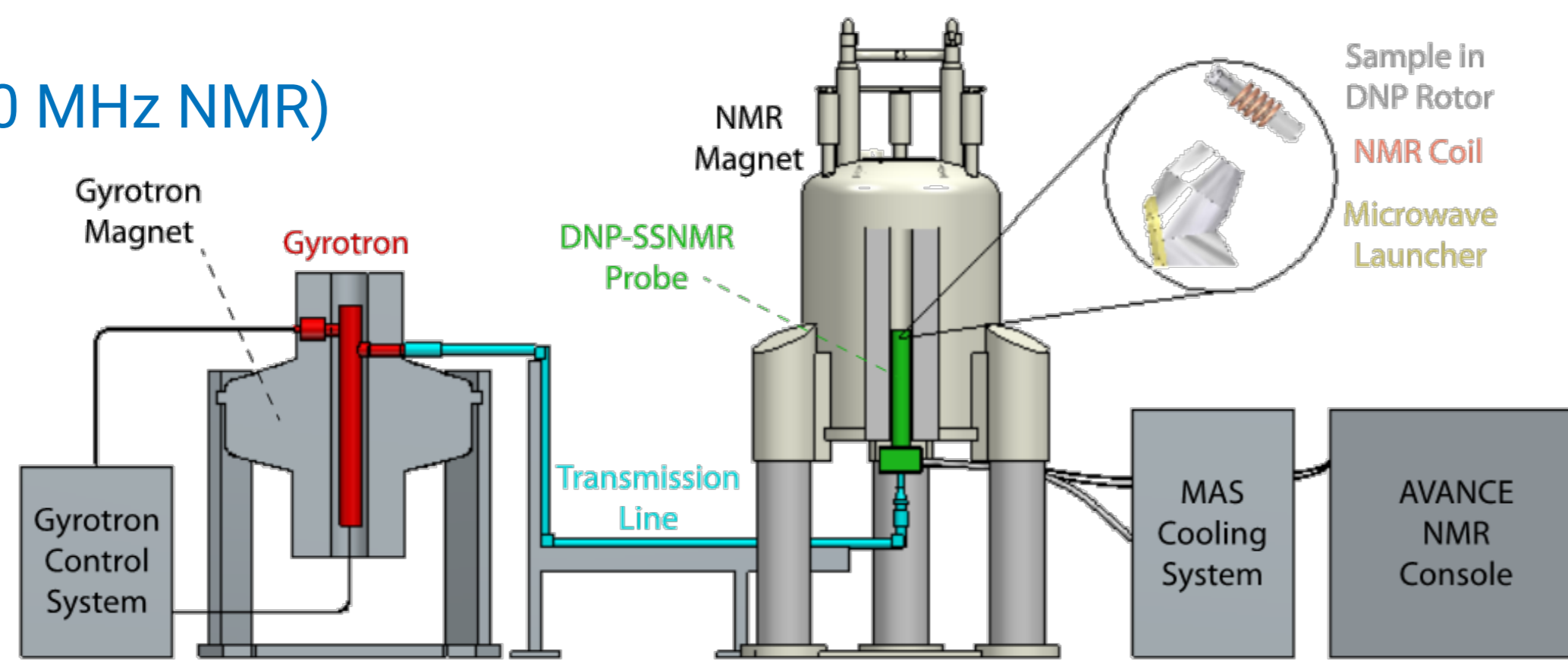

Klystrons (for 400 MHz only) 80% DNP performance at ~70% cost! with CPI Canada

- 5 W output
- stable operation
- small footprint
- simple facility needs
- 20k operational hours (up to 5-10 years, dep. on usage)

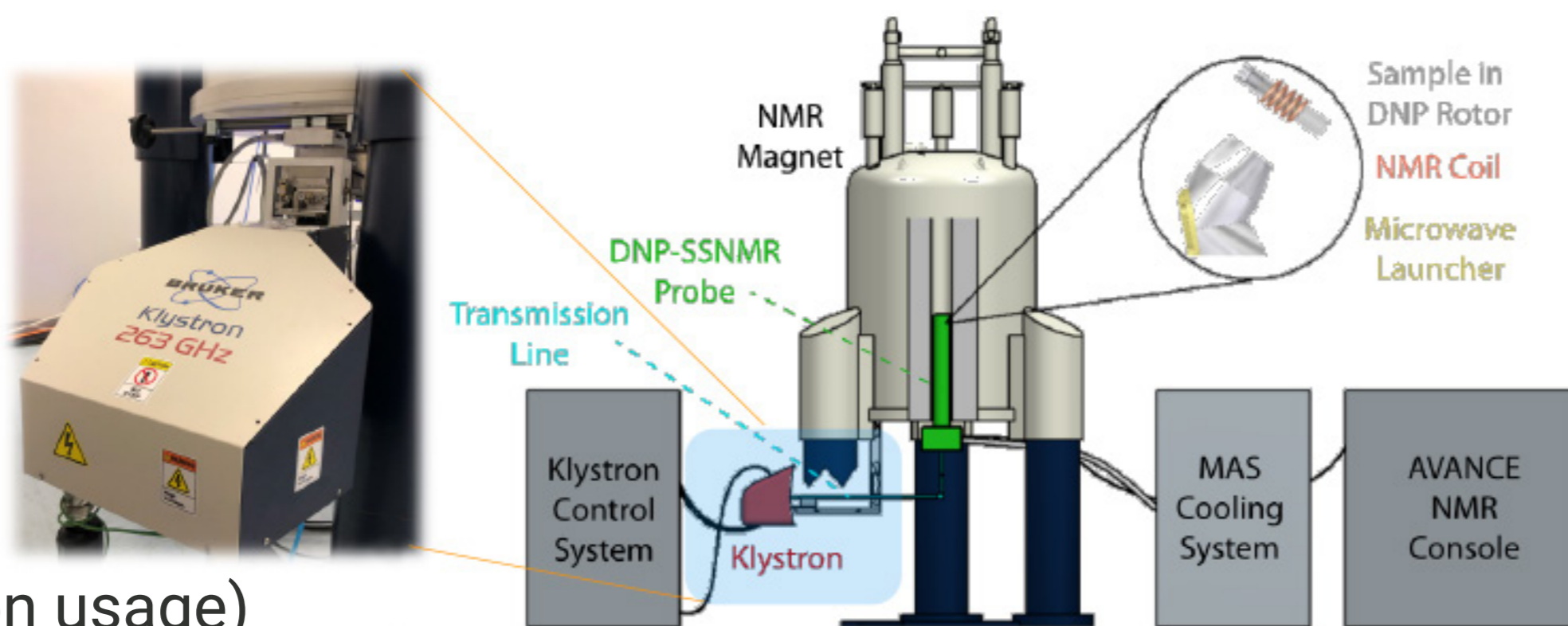

3rd-generation LT-MAS Cooling Cabinet

- Updated main control unit
 - integrated Topspin control (≥4.3, ≥3.7) → →
 - improved regulation (pressure, flow and fill)
 - integrated venturi for fast probes (≤1.9 mm)
- MAS-3 controller integration
 - automated cold insert/eject & spin up/down
 - best-in-field spin regulation
- Improved cryogenic efficiency
- Touch-panel GUI – duplicates TS functionality

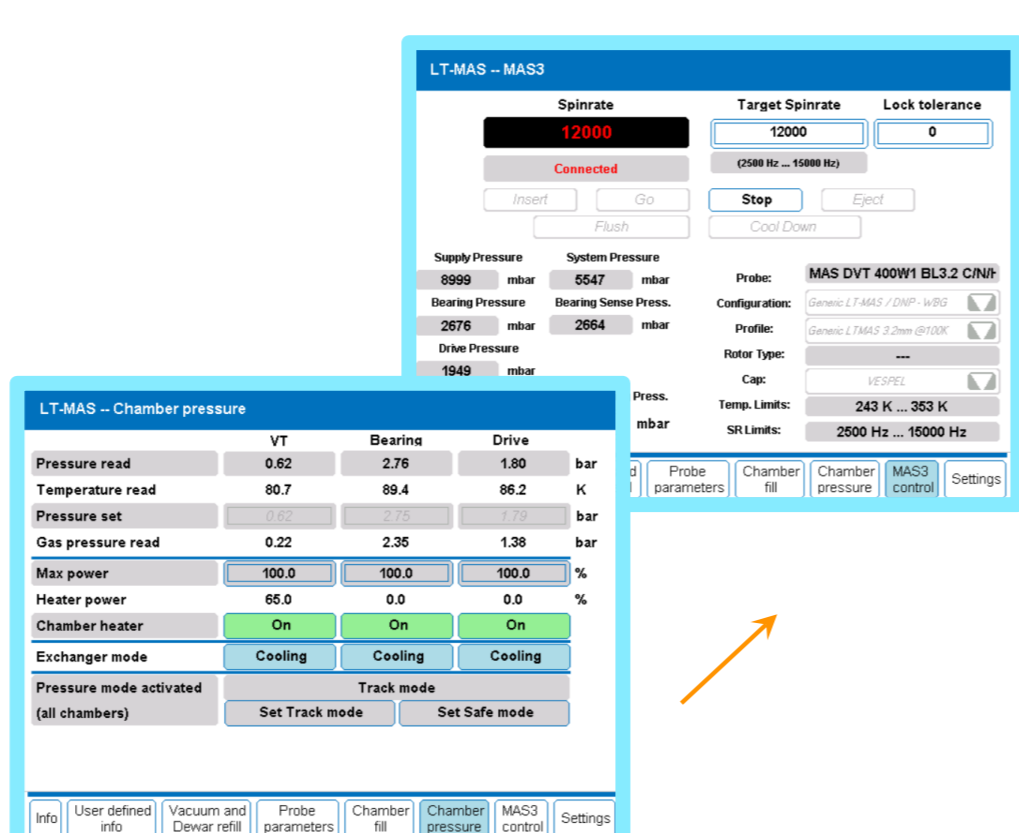
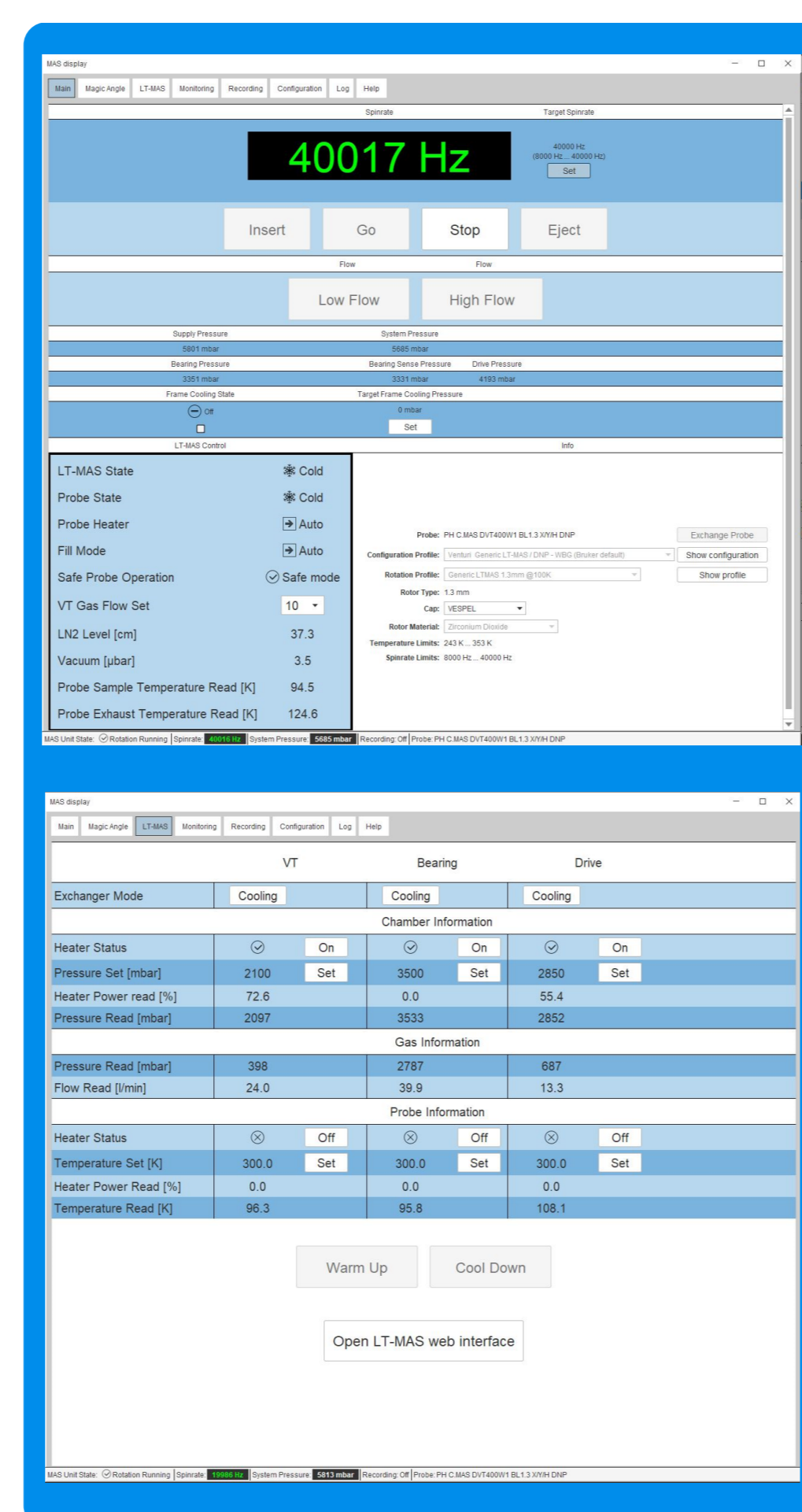

Standard-Bore DNP (Technology Development)

SB DNP probes will enable solids NMR for customers with new or existing 600 & 800 MHz SB magnets. They also pave the way for DNP with GHz NMR systems, where all NMR is in SB magnets.

- DNP performance is uncompromised, with same DNP gains as with our WB probes.

- Data from 1.3 mm Prototypes



- 190x SNR @ 600 MHz
- 80x SNR @ 800 MHz

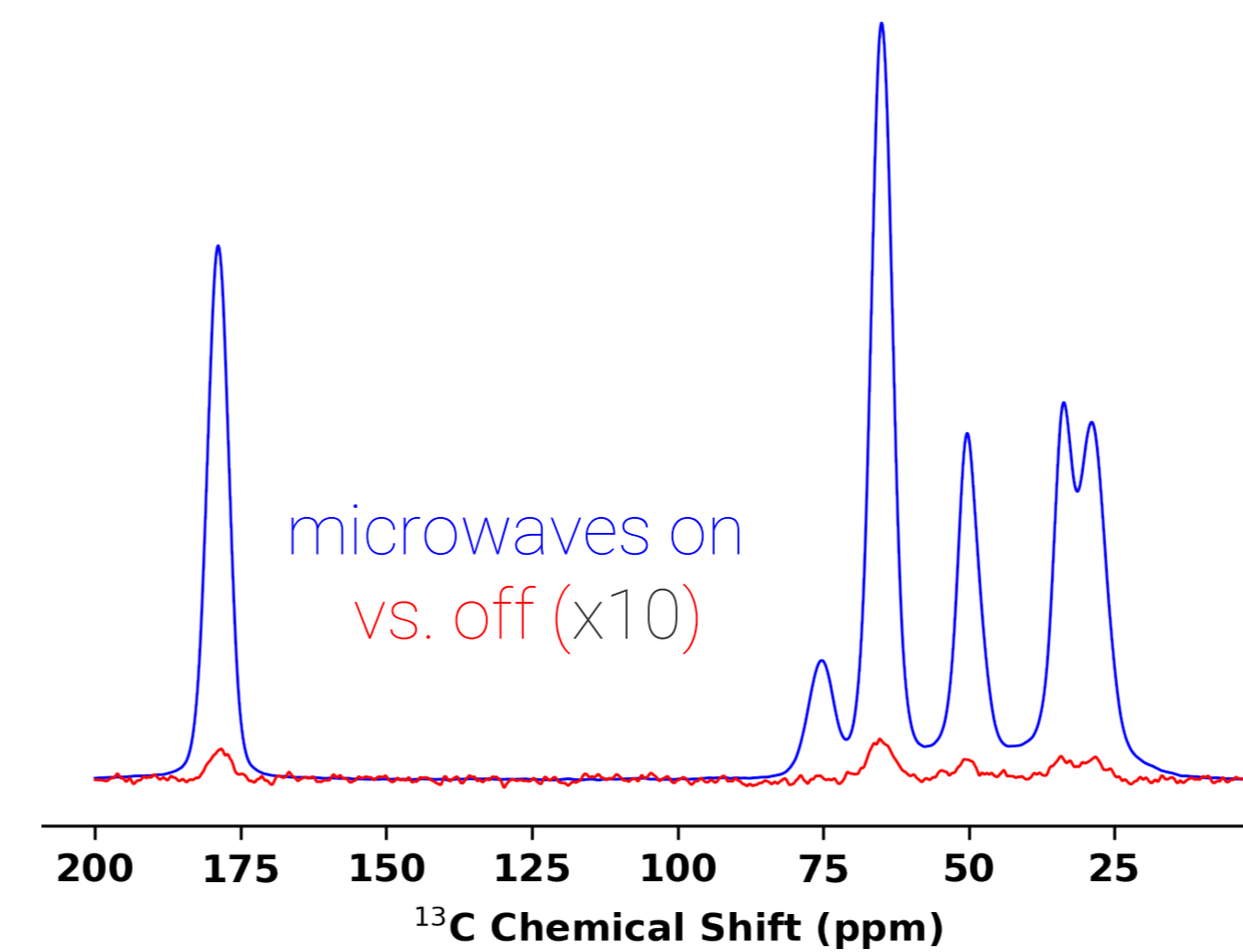

SB LT-MAS DNP Family (600 – 1200 MHz)

- ✓ H/C/ N (fixed only, no X/Y)
- ✓ H/X
- ✓ 1.3 mm (40 kHz MAS @ 100 K)
- ✓ 0.7mm (65 kHz MAS @ 100 K)
- ✓ All with cold insert/eject
- ✓ < 100 K operation

DNP for 1.0 – 1.2 GHz (Technology Development)

- 1.x GHz NMR offers unparalleled sensitivity & resolution.
- LT-MAS DNP at ultrahigh field can yield further SNR gains of >100x vs. traditional CPMAS techniques.

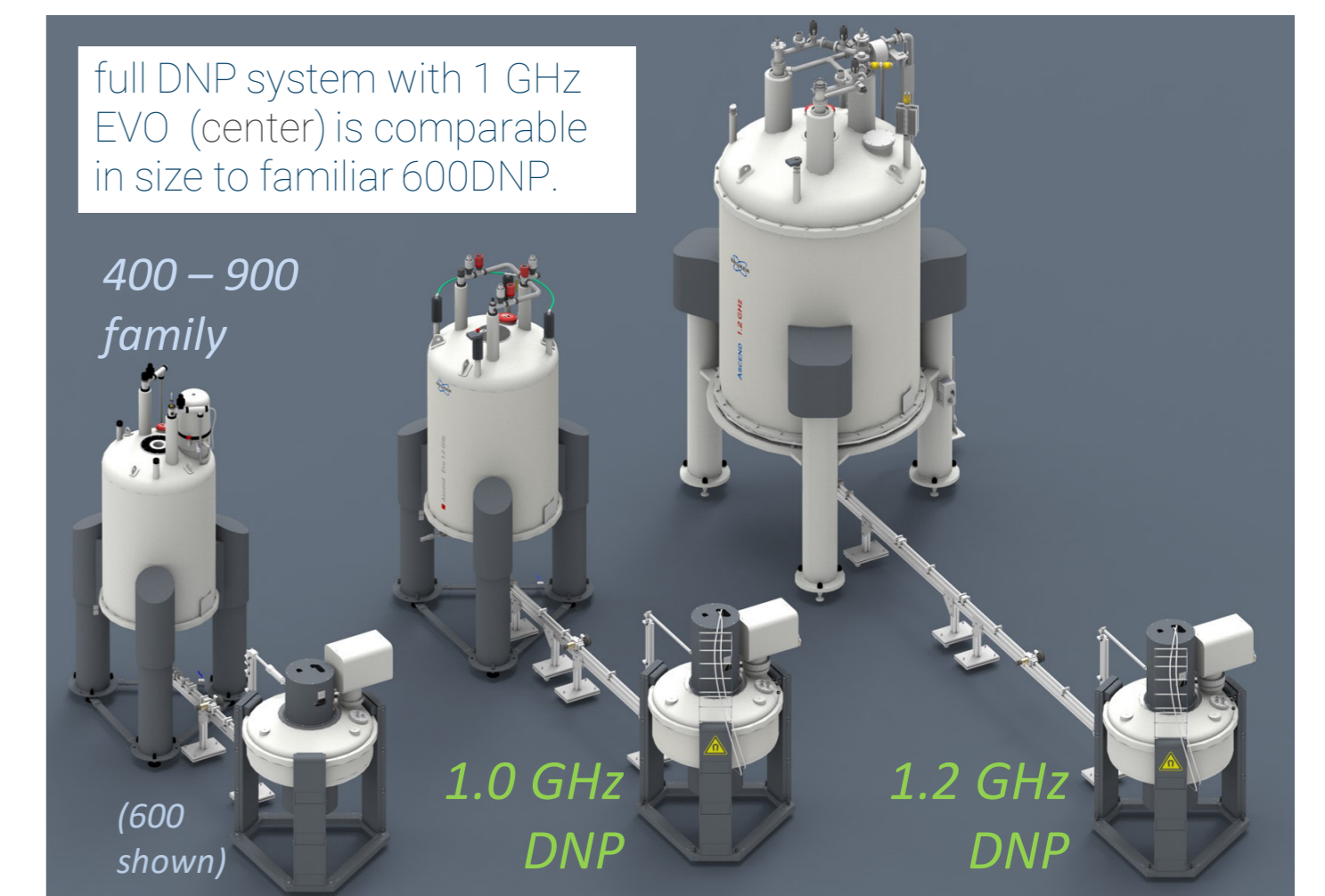

Gyrotrons for the 658 – 790 GHz range (as well as SB DNP probes) have been the missing piece for ultrahigh field DNP.

- Previously, our Gyrotrons reached up to 593 GHz for 900 MHz NMR.

Now, we have designed a new gyrotron family for DNP at 1.x GHz

- As before, we utilize a 2nd-harmonic microwave generation in cryofree magnets.
- New Bruker superconducting tech. enables up to 14.5 T magnets without increasing the footprint of our Gyrotron.
- CW microwaves at >30 W power with frequency tuning to cover a variety of radicals for DNP.

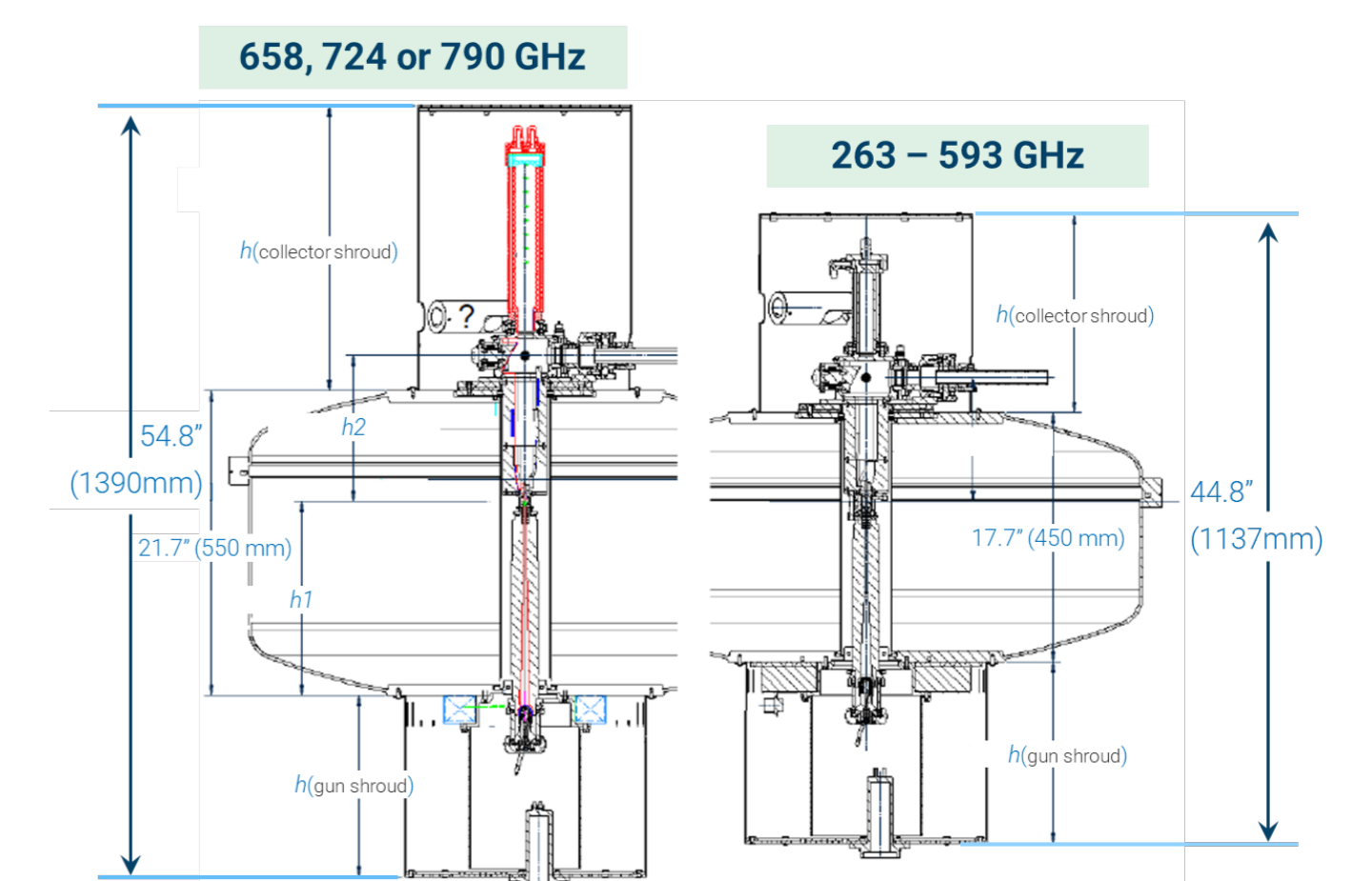

Cross-sectional view of Gyrotrons for up to 1.2 GHz (left), only 20 cm taller in the magnet stand and with matching diameter and footprint vs. to the 400 – 900 MHz family (right).

Conclusion

- Bruker offers turn-key solutions for DNP-enhanced LT-MAS solids NMR from 400 – 900 MHz with unmatched performance & reliability.
 - Gen-3 LT-MAS for higher-performance & user-friendly operation
 - Microwave & WB Probe options to meet all your needs.
- Standard-Bore DNP probes offer a way to perform DNP experiments on existing 600, 800 SB magnets as well as new 1.0 – 1.2 GHz NMR systems.
- Gyrotrons now in development to enable DNP NMR at 1.0 – 1.2 GHz.