

M6 JETSTREAM

Large Area Micro X-ray Fluorescence Scanner

State of the Art in Spatially Resolved Elemental Analysis of Large Objects



The M6 JETSTREAM is designed for the non-invasive in-situ elemental analysis of large objects using X-ray fluorescence, also known as MA-XRF. Using Bruker's most innovative micro-XRF technology over a large area, it creates a precise elemental image of the scanned object. Resolution and spot size can be adapted to perfectly match the sample structure. High excitation intensity and detection efficiency combined with the fast stage result in an exceptional speed of the M6 JETSTREAM and keep measurement times short. Its open design and mobility allow complete flexibility in the alignment with the object.

Main features

- **On-the-fly mapping of up to 800 x 600 mm² area** with up to 100 mm/s stage speed and millisecond acquisition time per pixel
- **Vertical, tilted, and horizontal measurement orientation** with wheeled base for mobility and flexible positioning
- **State-of-the-art polycapillary X-ray optics** with adjustable calibrated spot size from 100 μ m to ~ 600 μ m
- **Dual large area Bruker XFlash[®] detector option** for optimal data acquisition
- **Integrated ultra-sonic distance sensor** for collision protection
- **Sophisticated software interface** for advanced data evaluation, including qualitative display options and quantification
- **Electronically controlled helium purge option** for enhanced light element performance
- **2D PLUS mapping with Aperture Management System** for higher X-ray focal depth and improved results on samples with large topography

An Insight into the Art of Nature

The M6 JETSTREAM expands the capabilities of micro-XRF to large and heavy samples in many fields of scientific research. Often, the size and fragility of such samples only allows horizontal positioning and measurements in top-down geometry. The flexibility of the M6 JETSTREAM opens up the possibility to create compositional overview images of samples ranging from fossils over geological samples to technical components. This allows measurements previously only possible at synchrotron facilities.

Application example – Elemental analysis of a fossil

The scanned sample represents the first full scan of an early bird theropod. This unique specimen of *Jianianhualong tengi* was fully analyzed in one run (500 μm step size) and with higher resolution (200 μm step size) on the skull. The elemental maps were used to verify the integrity of the fossil and gain further insights on the bone structure and composition (Data courtesy of Xinghai Museum, Dalian and Dr. Roald Tagle).

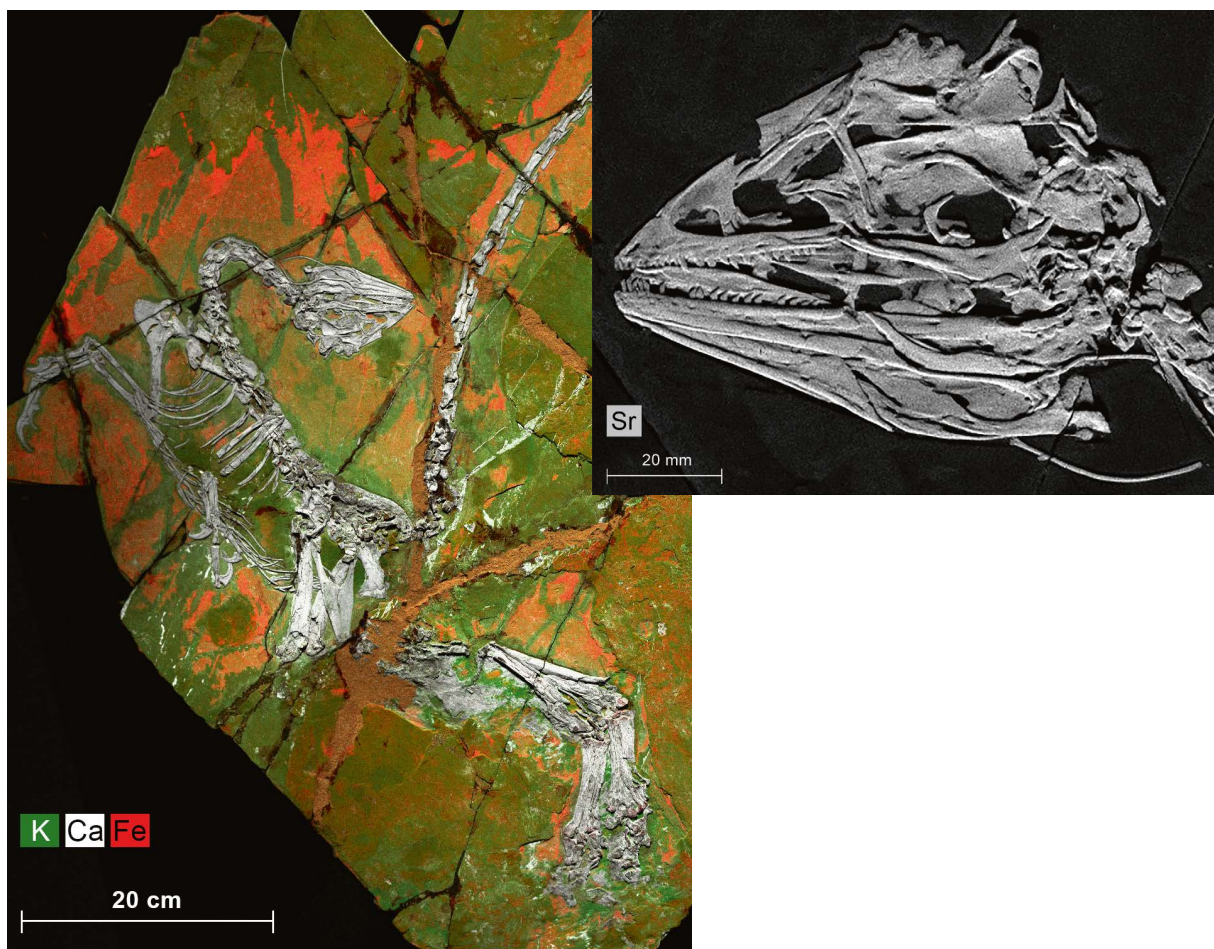

The potassium (green) is used to show the mineral around the fossil while iron (red) is distributed mainly in the surroundings of the fossil. The bones were visualized using the calcium or equally distributed strontium signal (white).

A Deeper Look into Cultural Heritage

Due to its unique design as an open beam micro-XRF scanner, the M6 JETSTREAM has become a key tool to obtain a better understanding of works of art. Studies carried out at multiple institutions around the world unravel countless stories of hidden features in paintings or lay the foundation of substantial conservation projects.

With the M6 JETSTREAM large objects can be analyzed on site by simply positioning the instrument in front of the artwork, either in the lab or at the exhibition site, making the science of restoration accessible to museum visitors.

Application example – Analysis of a large painting

This “The Virgin of the Rocks”, created by the famous artist and scholar Leonardo da Vinci (1452-1519), is the later version of two paintings displaying the Madonna and Jesus with the infant John the Baptist and the angel Uriel.

Using the Bruker M6 JETSTREAM it was possible to highlight a sketch of a previous composition of the image, visible in the element distribution map of zinc. Later this sketch was painted over by the artist, making the image more similar to the version now in the Louvre, Paris.



“The Virgin of the Rocks” by Leonardo da Vinci, about 1491/2-9 and 1506-8, oil on poplar, thinned and cradled. Courtesy of National Gallery London (NG1093). Measurement data and images courtesy and copyright of the Scientific Department of the National Gallery. Source: M. Spring, M. Melchiorre Di Crescenzo, C. Higgitt and R. Billinge, ‘Leonardo’s Virgin of the Rocks in the National Gallery, London; new discoveries from macro X-ray fluorescence scanning and reflectance imaging spectroscopy’, *National Gallery Technical Bulletin*, 41, 2021.

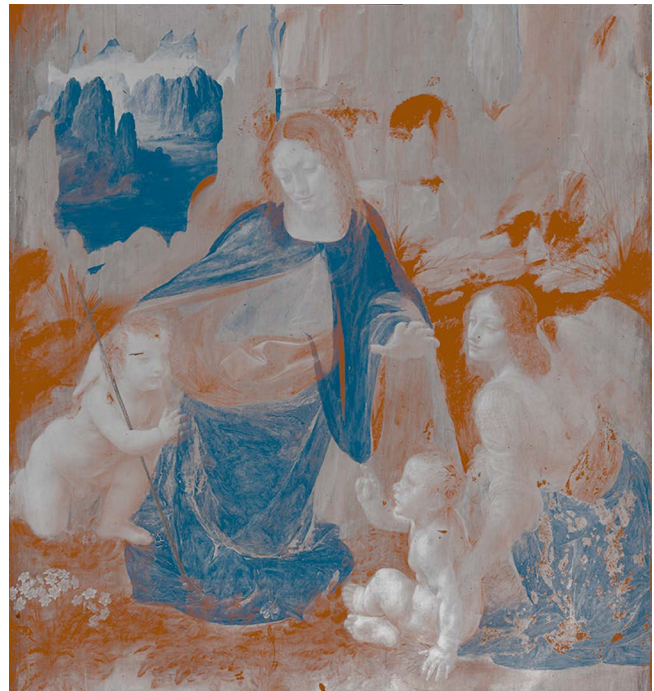

Distribution of copper (blue) associated with the blue pigment azurite, and iron (brown) associated with yellow, red, brown and greenish earth pigments. The painting (189.5 cm x 120 cm) was scanned in 10 sections at a step size of 350 μm and a dwell time of 10 ms. Element maps were stitched to create the element distribution images.

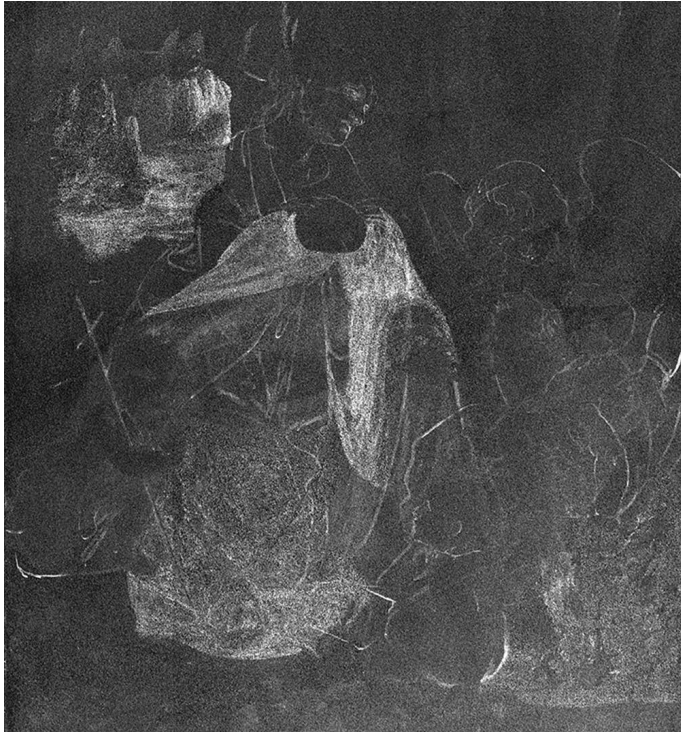

Distribution of Zn (following additional signal and image processing), revealing the initial sketch.

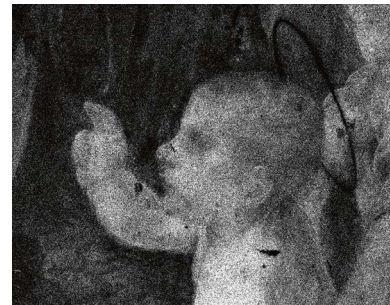

The comparison of Pb-L lines (top) emerging from deeper layers of the painting with Pb-M lines (bottom) from the surface show that the orientation of Jesus' face was changed from three-quarter to profile view.

Application example – Analysis of a large artifact

Investigating the composition and compositional variations of ancient objects can tell us about the status of an object as well as techniques used in their production.

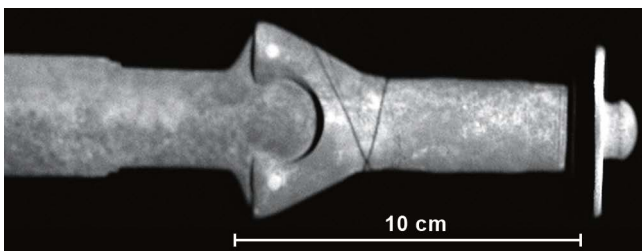

Maps of a metal full-grip sword from central Europe, dated ~1100 BC, conducted with 1668 x 667 pixels, step size 400 μ m, spot size 600 μ m in ~4 h overall measurement time. Measurement data courtesy of Chimei Museum Foundation, Taiwan.

Top: The copper distribution in the sword's bronze grip clearly shows two copper nails fastening the grip.

First right: Mosaic picture of the sword taken with the built-in camera of the M6 JETSTREAM.

Second right: Copper distribution displayed as single element in gray.

Third right: Copper distribution separated into different phases using the Auto-Phase function.

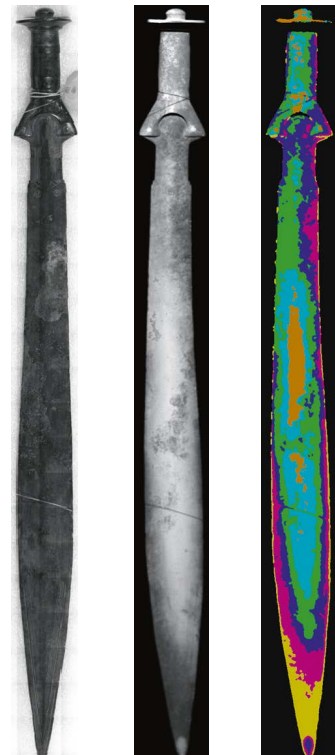

Technology Benefits

The M6 JETSTREAM offers a wide range of benefits through its innovative technologies.

Element detection beginning from sodium (Na) with the optional helium flush or aluminum (Al) without the use of helium. The recorded data can be analyzed qualitatively or quantitatively, stored as single spectrum or as HyperMap Data Cube with all optical images and complete spectral information per pixel. All data can be exported to open data formats for external evaluations. The instrument software includes the possibility to generate a line scan or 2D elemental distribution images with a variety of tools for data evaluation.

Two independent cameras provide live images for sample inspection and accurate positioning. One camera has a field of view of ~3 cm width, while the other magnifies to an image section of ~1 cm field of view.

Images can be stitched to a mosaic image over the complete scanning range for definition of the analytic area.

The instrument hardware includes several adjustment options to align the measurement position to the sample. To facilitate instrument movement and transport, an optional flight case set, specially designed for safe and easy transport of the complete instrument, is available.

As an open beam system, the M6 JETSTREAM includes multiple X-ray safety features inspired by Bruker's long experience in this field. These features include software independent safety electronics, a safety check before starting a measurement to protect the operators around the instrument, and a door interlock option. Ultrasonic crash protection sensors are installed to prevent a collision with the scanned objects.

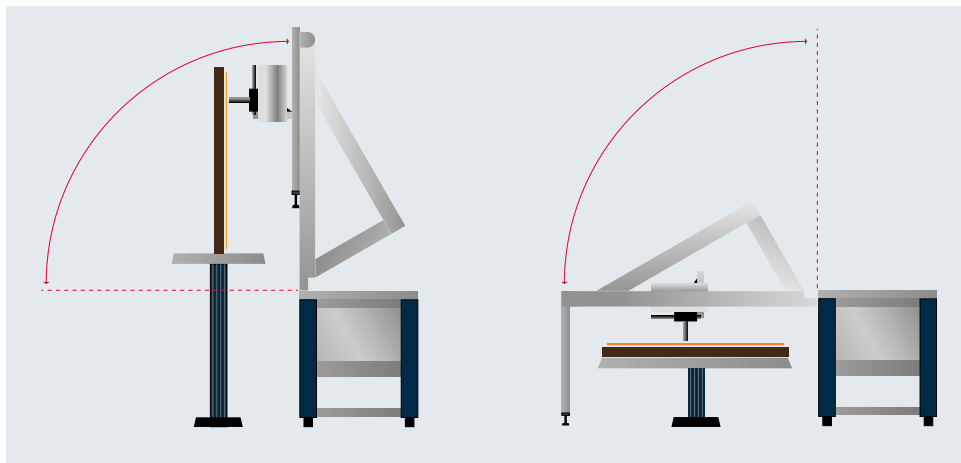

The M6 JETSTREAM can be positioned in two modes: an upright measurement position (left) to allow scans of upright or hanging objects or in a horizontal mode (right) allowing sample placement below the scanner frame. In the upright position the rig can be tilted by $\pm 10^\circ$.

Fields of Application

- **Arts and Conservation** – the non-invasive elemental analysis capabilities combined with the large high-speed scanning range makes the M6 JETSTREAM a valuable tool for this field.
- **Material Science Research** – the mobile M6 JETSTREAM enables on-site screening of large and heavy parts for research and

development as well as failure analysis in an industrial environment.

- **Geoscience** – with its highly flexible measurement options and multi-element sensitivity, the M6 JETSTREAM enables high-quality analyses of large drill cores or mineral samples.

Configuration Options

Double Detector with high Throughput

The M6 JETSTREAM can be equipped with two Bruker XFlash® silicon drift detectors mounted symmetrically, looking from the left and right, to increase the sensitivity and reduce shadowing effects from uneven samples. The double detector option is available with 2 x 30 mm² SDD area or 2 x 60 mm², all options offer a resolution of <145 eV @ Mn-K α and a maximum achievable signal output of more than 500 kcps.

Aperture Management System (AMS)

When mapping a topographic sample, the spot size changes with the distance to the optics. The AMS was designed to minimize this divergence of the beam, in order to enable high-resolution mapping on a large variety of objects. The M6 JETSTREAM 260 offers two AMS options to adjust the depth of field and the spot size to almost any requirement.

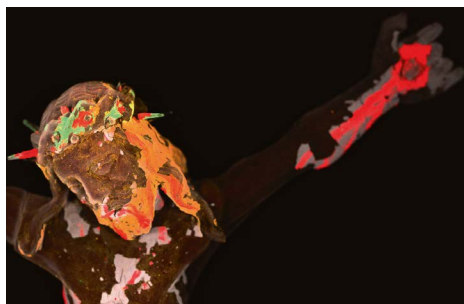
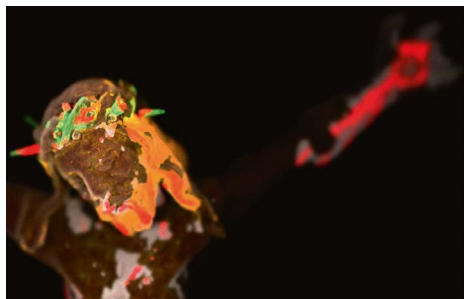

Polychrome medieval wooden statue (5 cm maximum topography) measured without AMS (top) and with AMS 500 (bottom).

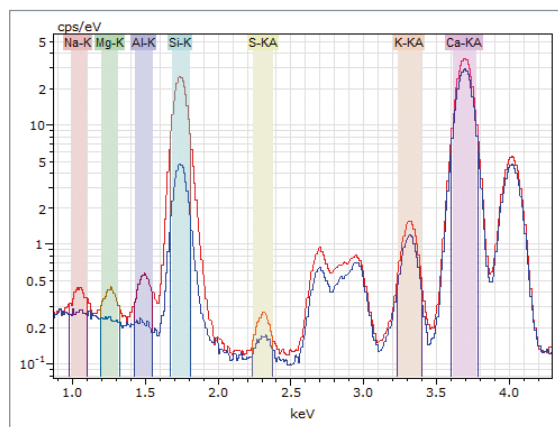

Micro-XRF spectra of a soda-lime float glass (NIST 620) measured with He purge (red) and without He purge (blue). The sensitivity for light elements is improved by He purge during measurements.

Helium Purge System

Due to the absorption of the low-energy fluorescence by air, all open-beam XRF spectrometers are limited in the detection of light elements. The M6 JETSTREAM can be upgraded with a software-controlled Helium flush system to drive out air from the detection path. This strongly improves the detection limit of all elements below calcium (Ca) in the periodic table, allowing detection down to sodium (Na).

Flight Case System

The flight case system with two durable cases on wheels ensures the optimal protection of the M6 JETSTREAM and all its components during transport. The kinematics case (1510 x 1916 x 760 mm³, 126 kg) houses the frame of the M6 JETSTREAM and accessories.

The electronics case (1593 x 1535 x 715 mm³, 99 kg) safely accommodates the lower frame components. Simple packing or unpacking is ensured by the integrated ramp.



Technical Specifications



	M6 200	M6 260
Excitation	Microfocus X-ray tube, 50 kV, 600 μ A Rh anode (other material on request), polycapillary lens	
Excitation options	8 primary filters	6 primary filters and Aperture Management System (AMS) for higher depth of focus with two aperture sizes
Spot size	Adjustable from 100 μ m to ~ 600 μ m in 5 steps	
Detection	Single 30 mm ² silicon drift detector (SDD), option for a second 30 mm ² SDD energy resolution < 145 eV for Mn-K α , up to 275 kcps throughput per detector	Dual 60 mm ² SDD
Light element detection	Optional Helium purge system for detection of elements from Z = 11 (Na) to 20 (Ca)	
Sample view	2 color cameras, capturing images with a size of 30 x 22 mm ² and 11 x 8 mm ² , respectively. The high magnification camera permits changing focal length to adjust the working distance.	
Scanning range	W x H: 800 x 600 mm ² Minimum step size: 10 μ m Maximum stage speed: 100 mm/s	
Mechanical features	The measurement rig can be tilted by $\pm 10^\circ$ in vertical measurement direction. The frame can be tilted to horizontal position for top-down measurements. The complete instrument can be moved using the integrated wheels.	
Control unit	Instrument control via state-of-the-art PC, complete package with TFT monitor, keyboard and mouse	
Software	M6 JETSTREAM software package with: <ul style="list-style-type: none"> ■ Instrument control of measurement positioning, detection, imaging, excitation conditions, measurement time and safety circuitry ■ Spectra acquisition and display on one or multiple measurement points ■ Distribution analysis with LineScan ■ Area mapping with HyperMap functionality for more the 4 Mpixels ■ Fundamental Parameter quantification for all measurement modes ■ Report manager 	
Instrument size	W x D x H: 1400 mm x 1800 mm x 1560 mm (horizontal position) W x D x H: 1400 mm x 650 mm x 2250 mm (vertical position) Weight: approx. 200 kg The instrument can be dismantled into 4 parts for transportation.	
Mains	100/240 V, 50/60 Hz, max. power consumption 400 W (without PC and monitor)	

Bruker Nano Analytics

Headquarters Berlin · Germany
Phone +49 (30) 670990-0
Fax +49 (30) 670990-30
info.bna@bruker.com

www.bruker.com/m6jetstream

