

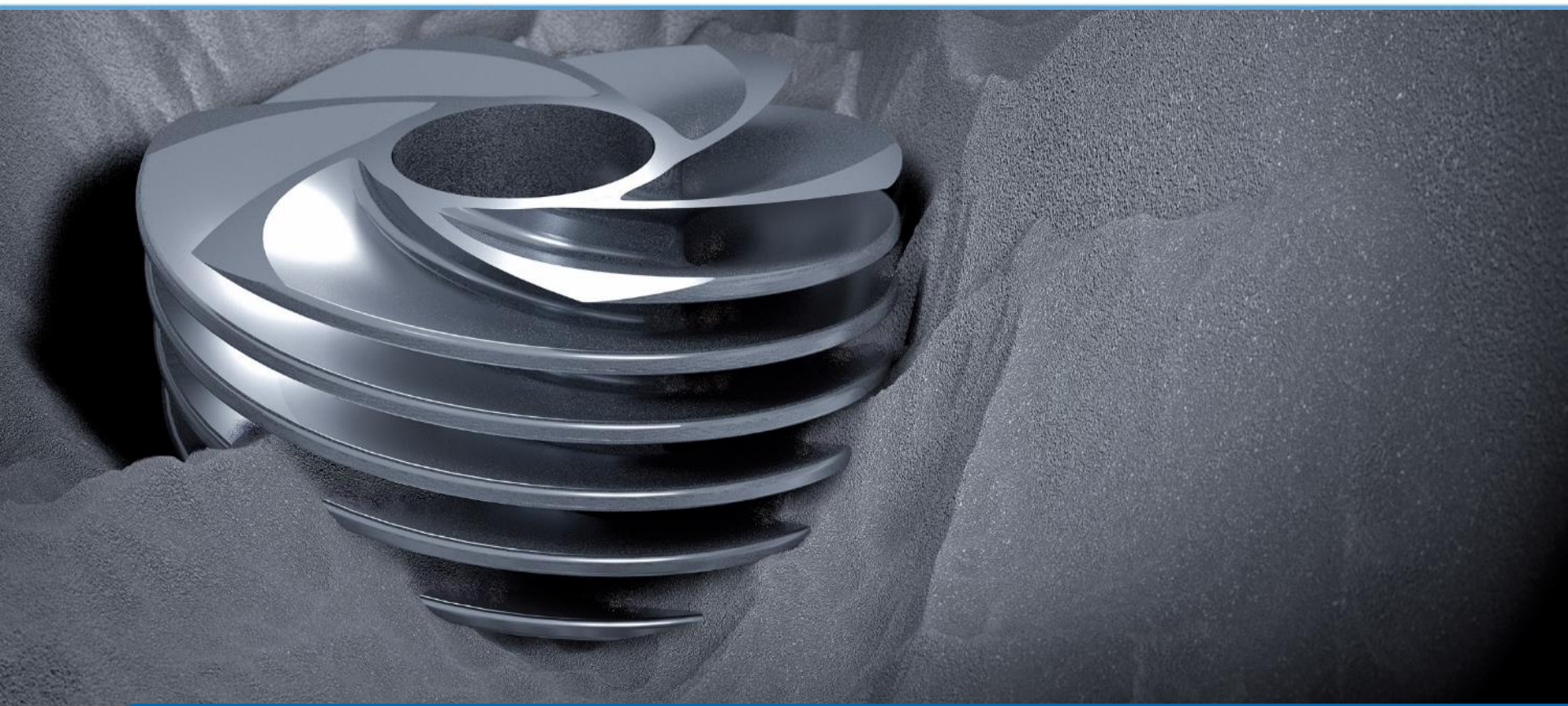

Light Element Analysis (C, S / O, N, H, Ar) Solutions for Additive Manufacturing of Metals



Audience Poll



Do you currently analyze any light elements (C,S/O,N,H) for any part of your AM process?

- Yes
- No
- N/A



Content

Additive Manufacturing



- Introduction to Presenters
- Introduction to AM
- Benefits / Considerations of AM
- Production of Powders for AM
- Techniques used for printed parts
- Why worry about CS / ONH / Ar
- Inert Gas Fusion (ONH,Ar)
- Combustion Gas Analysis (CS)
- Case study
- Complementary techniques BAXS
- Q and A



Welcome!

Meet your speakers



Kristin Odegaard
Sr. Sales Engineer OES, CS/ONH
Analysis
Bruker
Madison, WI



Christian Zühlke
Business Development Manager
Elemental Analysis CS / ONH
Bruker
Karlsruhe, Germany

Additive manufacturing

An Introduction



Definition

„Additive Manufacturing (AM) is an appropriate name to describe the technologies that build 3D objects by adding layer-upon-layer of material, whether the material is plastic, metal, concrete [...]”

<http://additivemanufacturing.com>

CS/ONH solutions only address 3D metal printing!

There are three areas to address

- Powders
- Parts
- In-Process

Additive Manufacturing

Benefits



Edelstahl Rosswag

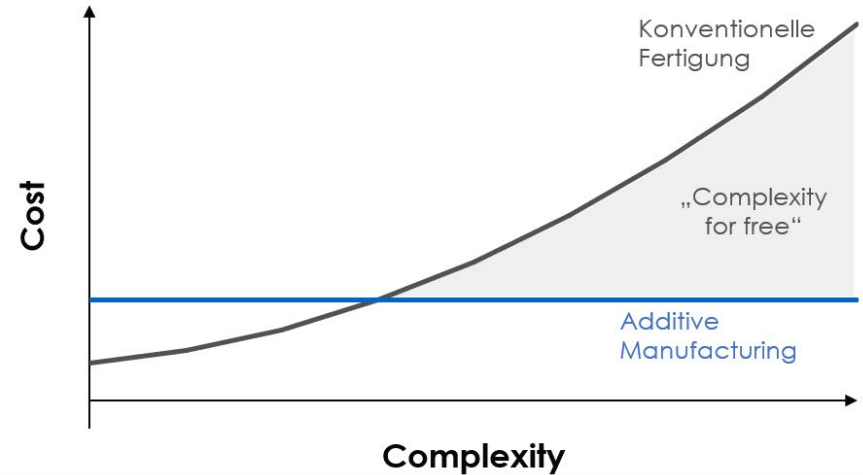

Complexity

- Functional optimization and high degree of geometrical freedom

Tailor Made Parts

- Able to create a part or structure to fit

Additive Manufacturing

Benefits



- Cost Reduction
- Small Batch's of Parts is Easier
- Assembly of parts not needed
- Reduced in-house inventory
- Easier to create and improve parts, with new and legacy pieces
- Improved part reliability
- Etc.....

Additive Manufacturing

Considerations



- Requires post processing
- Limited component size / Potential long print times
- Substantial effort in design and the knowledge needed to set up successful process parameters and printing
- Discontinuous production process (only can print one part at a time – depending on size)
- Ever evolving technique due to its “newness” unlike casting or subtractive manufacturing methods that has been around for ages
- **Quality of powder and printed parts**

Metal powders

How are they produced?



Process = Atomization

- 1. Gas (Ar, H, N) Atomization** – Most common method. Molten feedstock is forced through a nozzle where inert gas “nebulizes” the melt into small, mostly spherical particles (0 to 500 micron)
- 2. Water Atomization** – Used for unreactive materials (i.e. steel, less risk of surface contamination) and creates more irregularly shaped particles.
- 3. Plasma Atomization** – produces high quality and extremely spherical powders. Atomization by a plasma torch (0 – 200 micron)
- 4. Centrifugal Atomization** – Fine grain, homogenous, narrow distribution of sizes, excellent flowability but with low throughput. Quality between Gas and Plasma Atomization.

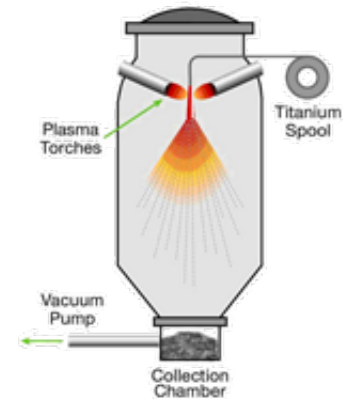
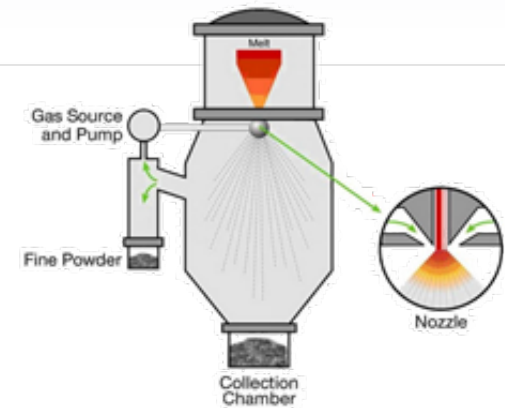

carpenteradditive

Metal Powders

Requirements

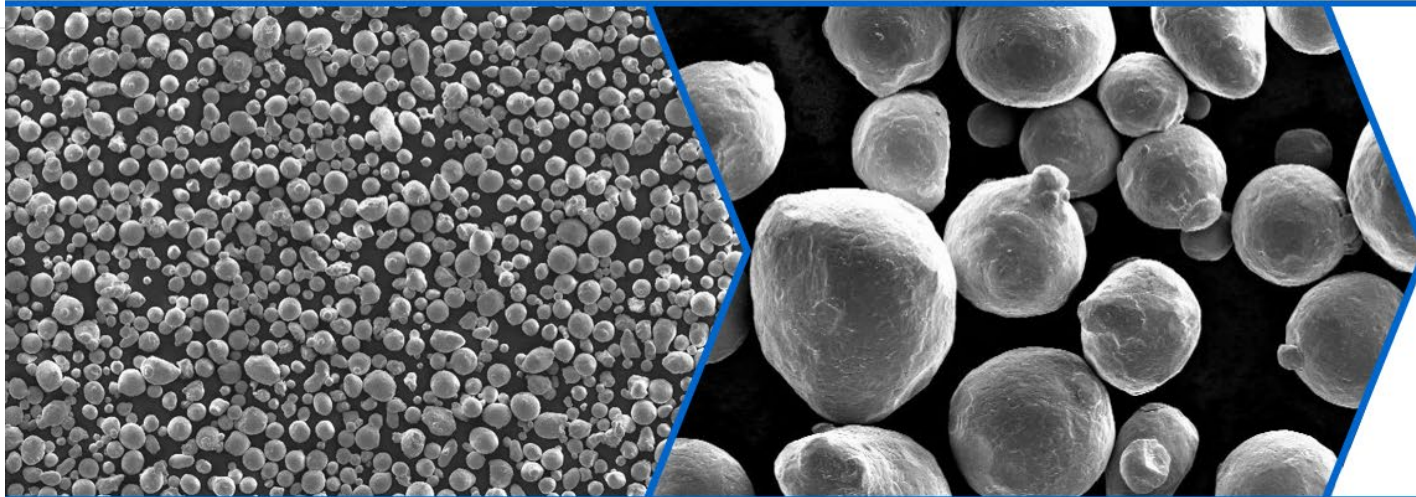

1.4404

1.2709

AlSi10Mg

TiAl6V4

Alloy 718

Edelstahl Rosswag

- Stable powder quality
- Homogeneous particle size and shape
- Minimize Ar, O and H contamination

The Finished Product

Examples of Different Processing Techniques



- 1) Press and Sinter Powder Metallurgy** – Conventional, preferred technology for Automotive/Home appliances parts (molded by compaction)
- 2) Metal Injecting Molding (MIM)** – Preferred technology for middle to high throughput small precision parts, Metal/Dental/Firearms (injection of molten metal into a mold)
- 3) Powder Bed** (3DP/EBM/DED/PBF/SLS/SLM-DMLS-LPBF) – Preferred technology for complex and high valued 3D Metal Printing parts (high value)
- 4) Binder Jetting** - Preferred technology for simpler, higher volume/higher throughput 3D Metal Printing parts – Automotive (uses binder to “glue” powder together) → Monitor C content

Relevance of O & H

“Effect of gases in metals”



Selective Laser Melting is related to welding – layer by layer - and shares the same challenges

Oxygen

- unwanted, parasite element
- steel: causing ageing brittleness
- titanium: degrades mech. properties (e.g. hardness)
- bulk (inclusions) vs. surface (corrosion)
- reactive metals like Ti, Mg, Al have high oxygen affinity

Hydrogen

- highly unwanted element
- causes harmful, complex embrittlement damages
- can be supplied during: welding, etching, annealing, high humidity/moisture
- Hydrogen effects tend to be less than oxygen induced effects

Relevance of O & H

Introduction

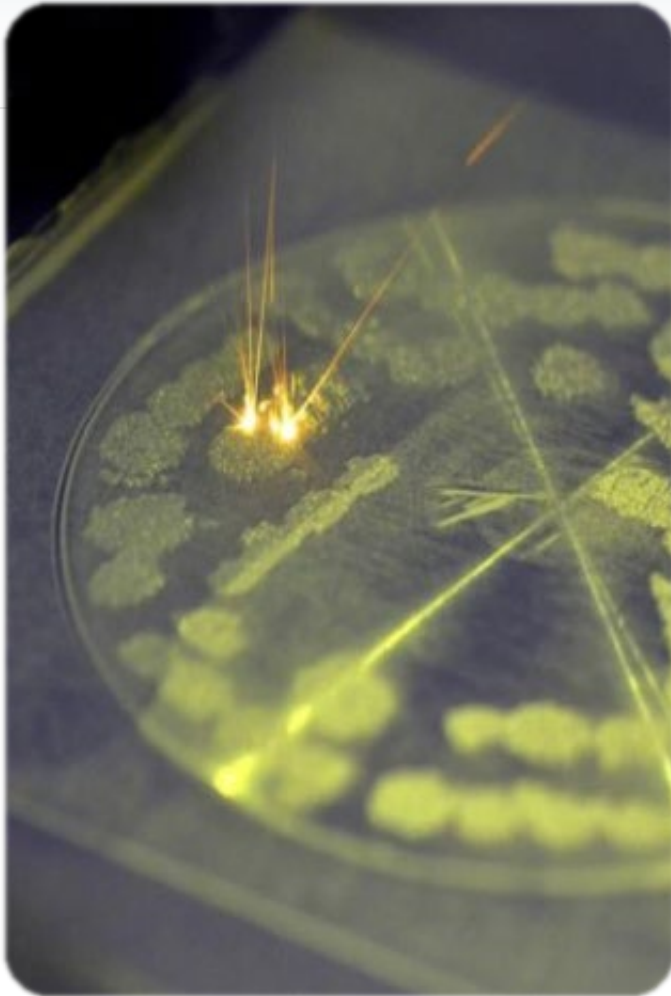

Chemical reactions on the metal particle surface play an important role during:

- Powder Production
- Storage
- Preparation for 3D printing
- Handling in the machine
- Powder Recycling

⇒ **Powder Aging**

Relevance of O & H



Powder Aging Factors



Powder aging will be faster:

- the smaller the particles are (high specific surface)
- the higher moisture and oxygen levels are
- the higher the temperature is
- the longer the exposition time is

Correlation between particle size and O, H content on the Same AlSi10Mg:

Particle Size / μm	Oxygen / ppm	Hydrogen / ppm
10 - 53 	1640 	68.2 
20 - 63	998	53.7
40 - 100	772	38.1

Relevance of Ar & N



- During the gas atomization, liquid metal is “nebulized” by a jet of a process gas (argon or nitrogen)
- Impurities in the gas like moisture, oxygen, etc. can react
- Traces of the process gas remain in the particles:
 - Ti, Al, Mg and other reactive alloys react with **nitrogen**
 - **Argon** is used as atomizing gas → does not react but remains in the powder **trapped in pores**
 - Ar causes embrittlement similar to hydrogen but starting at much smaller concentrations **<100 PPB**
 - Micro CT (μ CT) can't tell whether pore is filled with Ar
 - Post-processing (HIP) cannot remove a pore filled with argon gas
- **The Bruker solution is an IGF coupled to a mass spectrometer allows ppb detection limits of argon (and hydrogen)!**

Why Inert Gas Fusion?

How to best determine O, N, H and Ar



- Elemental Analysis Techniques are many but for light element analysis typical techniques do not work

~~XRF (WD) X-ray Fluorescence~~

- ~~• Sample Prep~~
- ~~• Low Fluorescence Yield~~

~~OES~~

- ~~• Not at very low concentrations~~
- ~~• ONLY solid metal samples~~

~~ICP (OES & AAS)~~

- ~~• Needs all samples dissolved in acids~~
- ~~• Torch is open to atmosphere~~

IGF (O,N,H,Ar)

CGA (C,S)

Inert Gas Fusion

Characteristics



Inert gas fusion is:

- A volumetric method (entire specimen is analyzed)
- A relative method that requires calibration (CRM or gas dosing) \Rightarrow result traceability
- Not limited in concentration ranges: high-ppb to 100%
- Fast (30s pre-cleaning of crucible, 60-90s measuring time)
- Applicable to all inorganic solids (must be dry!)
- Flexible by coupling a MS: Ar determination or isotopic tracers
- Able to deliver kinetic information by applying heating rates (e.g. separation of oxides)

What Type of Samples

How to best determine O, N, H and Ar



IGF allows for **any** dry inorganic sample type



Powder



Pieces



Turnings

G8 GALILEO



Mass Spectrometer

G6 LEONARDO



G8 GALILEO / G6 LEONARDO

How are gases released from the sample?



Inert gas fusion analysis

1. Graphite crucible is compressed between two electrodes.

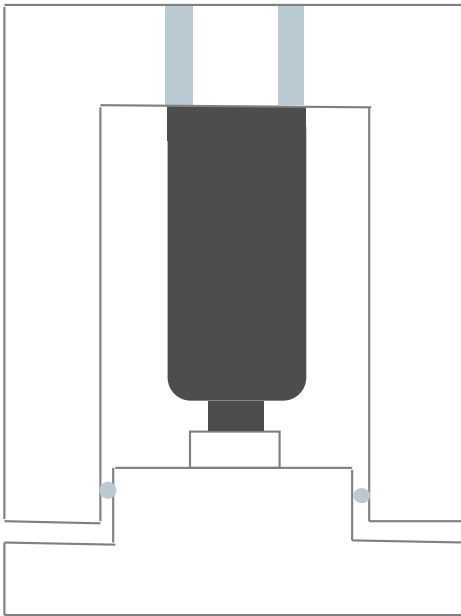

G8 GALILEO / G6 LEONARDO



How are gases released from the sample?

Inert gas fusion analysis

1. Graphite crucible is compressed between two electrodes.
2. Potential is applied across the two electrodes causing heating at the point of greatest resistance (crucible) – up to $3,000^{\circ}\text{C}$.

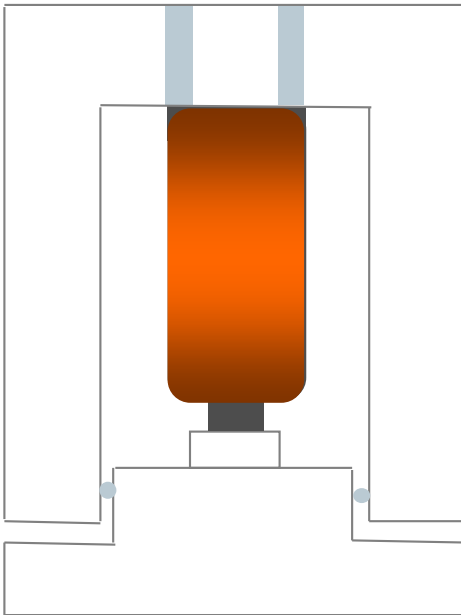

G8 GALILEO / G6 LEONARDO



How are gases released from the sample?

Inert gas fusion analysis

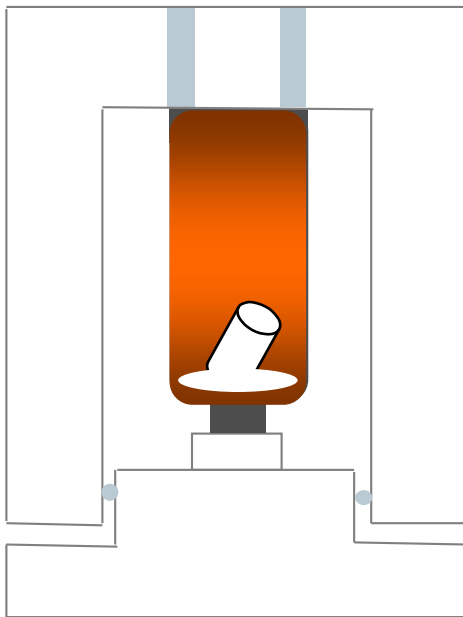

1. Graphite crucible is compressed between two electrodes.
2. Potential is applied across the two electrodes causing heating at the point of greatest resistance (crucible) – up to $3,000^{\circ}\text{C}$.
3. Sample dropped into the hot crucible fuses (melts) and releases forms of oxygen, nitrogen, hydrogen and also argon.

G8 GALILEO / G6 LEONARDO

How are gases released from the sample?



Inert gas fusion analysis

1. Graphite crucible is compressed between two electrodes.
2. Potential is applied across the two electrodes causing heating at the point of greatest resistance (crucible) – up to $3,000^{\circ}\text{C}$.
3. Sample dropped into the hot crucible fuses (melts) and releases forms of oxygen, nitrogen, hydrogen and also argon.
4. Oxygen reacts with C from crucible to CO, N and H are released as N_2 and H_2 from the sample and are swept by carrier gas to detection system.

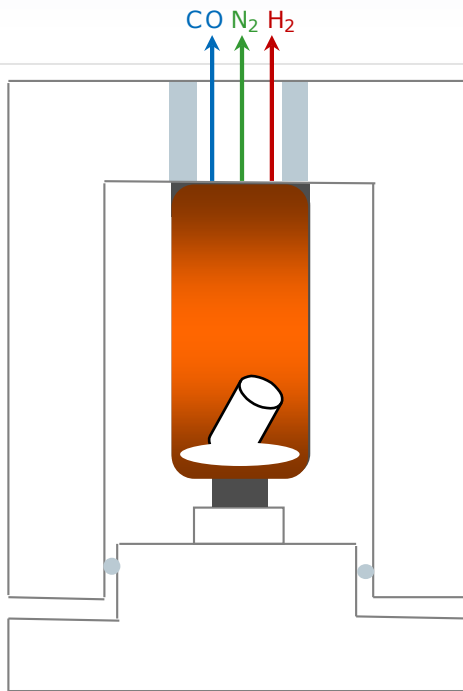

G8 GALILEO

Gas Flow Diagram

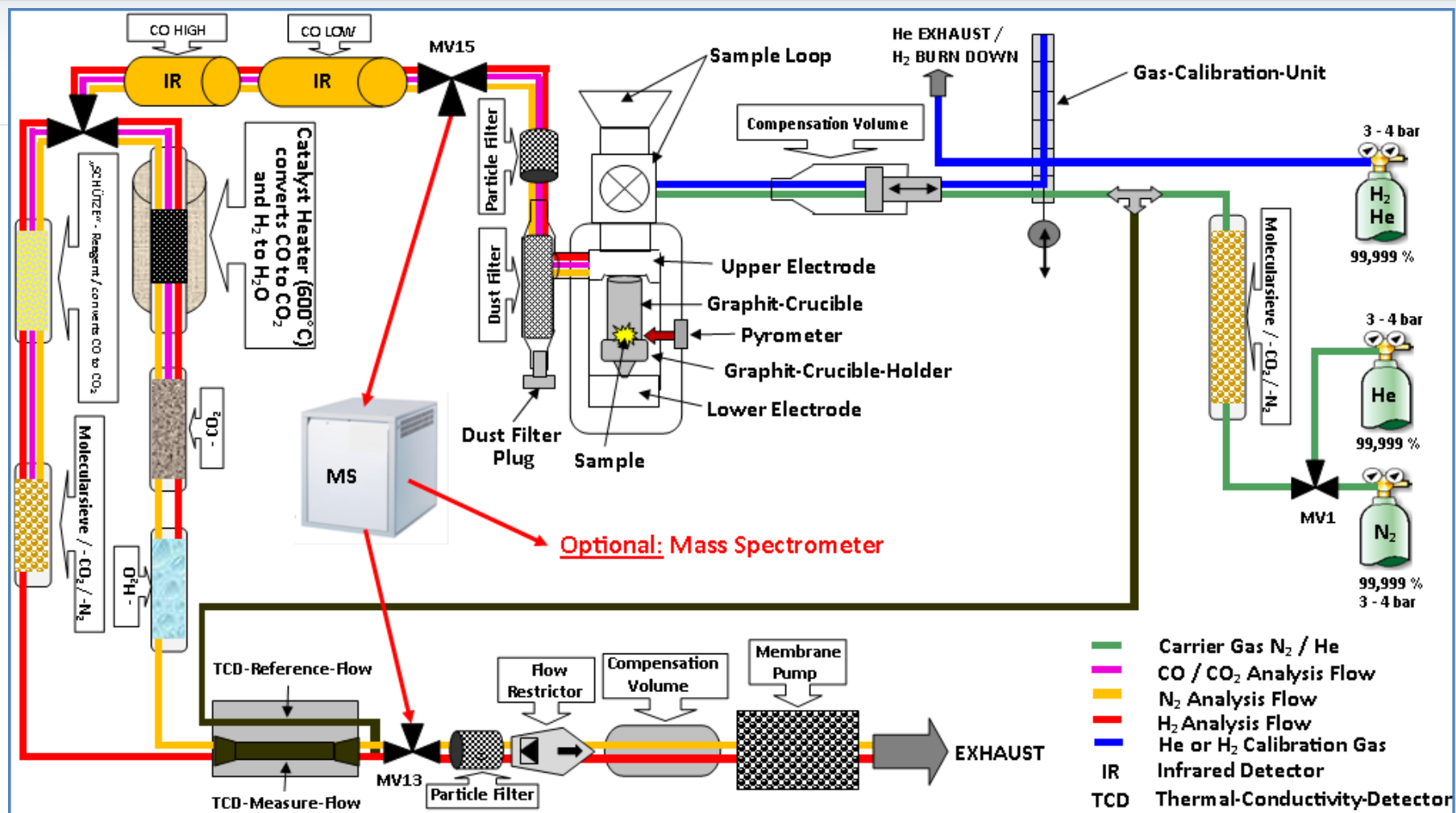

G8 GALILEO

Optional Benefits



Autocleaner



Gas Calibration Unit



Autosampler

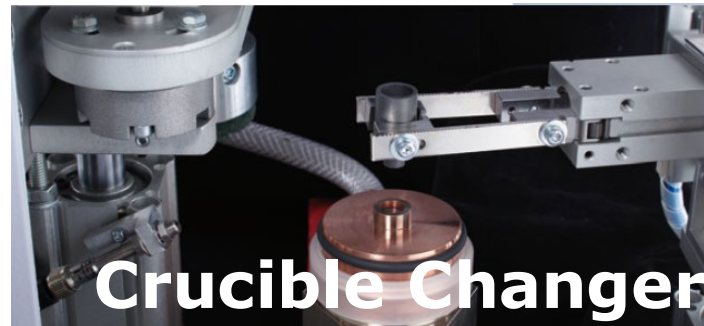

Crucible Changer



IR Furnace

Mass Spec

G4 ICARUS Series 2

Carbon & Sulfur Analysis



High precision C and S analysis in inorganic materials by combustion

Carbon analysis in additive manufacturing is only possible with the G4 ICARUS in powders and bulk.



G4 ICARUS Series 2

Typical samples



Inorganic solid samples

Examples: steel, copper, titanium, cast iron, refractories, carbides, minerals/mining, cement, metal powders (AM), ceramics



Pieces



Drillings/Chips



Coarse powders



Fine powders

Up to 1 g

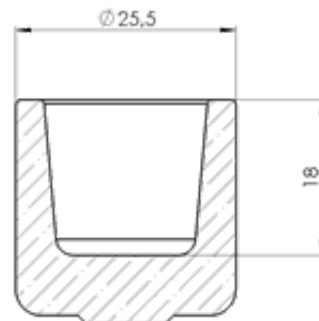

Ceramic crucible G4 ICARUS

G4 ICARUS Series 2

The principle of combustion



Combustion

[kuh m-buhs-chuh n]

the act or process of burning.

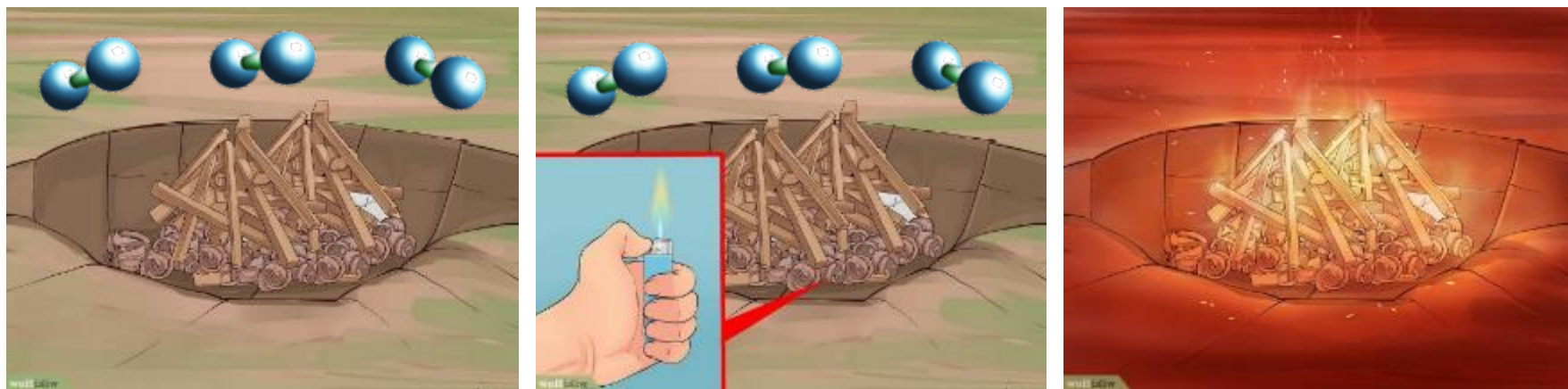

Combustion in chemistry:

- rapid oxidation accompanied by heat and, usually, light.

G4 ICARUS Series 2

The principle of combustion



combustion

[kuh m-buhs-chuh n]

the act or process of burning.



Combustion in chemistry:

- rapid oxidation accompanied by heat and, usually, light.

G4 ICARUS Series 2

Chemistry of Combustion



Solid sample + Accelerator
in Ceramic Crucible



G4 ICARUS Series 2

Chemistry of Combustion



Solid sample + accelerator
in ceramic crucible

Induction heating of the sample
Excess O_2 provided to sample

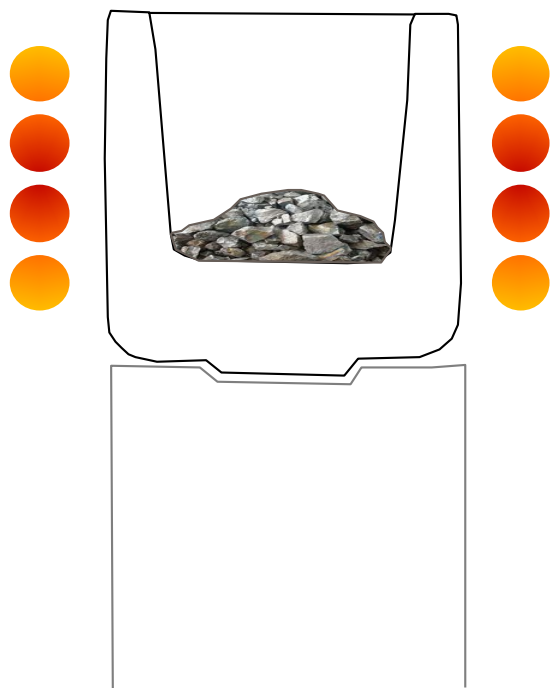

G4 ICARUS Series 2

Chemistry of Combustion



Solid sample + accelerator
in ceramic crucible

Induction heating of the sample
Excess O_2 provided to sample

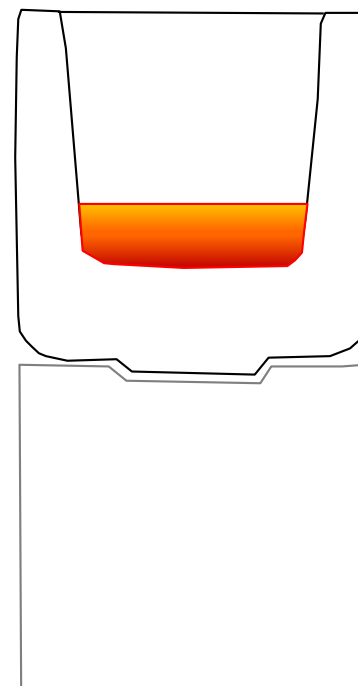
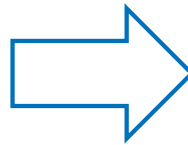
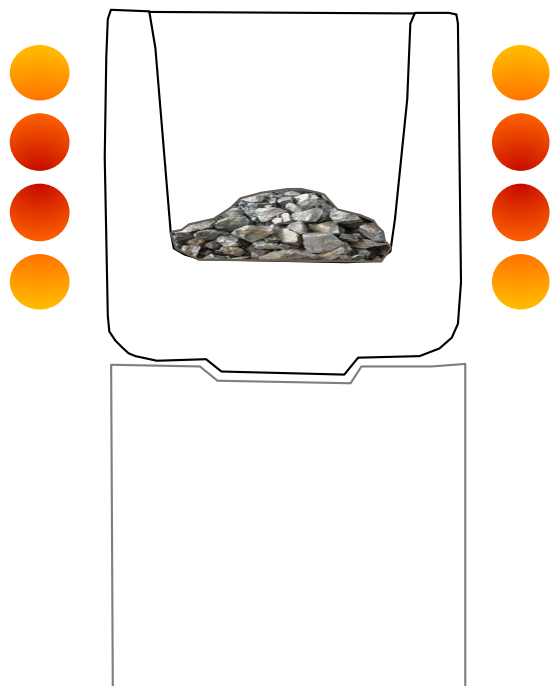

Sample melts

G4 ICARUS Series 2

Chemistry of Combustion



Solid sample + accelerator
in ceramic crucible

Induction heating of the sample
Excess O_2 provided to sample

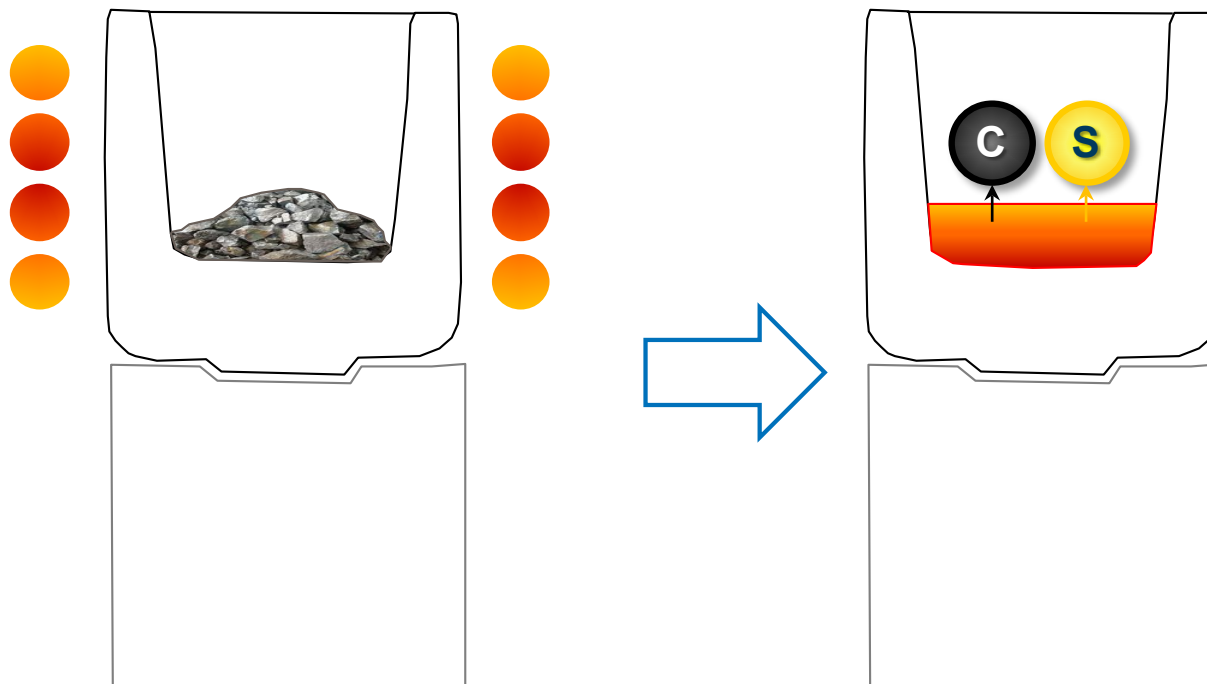

Sample melts

C & S are released

G4 ICARUS Series 2

Chemistry of Combustion



Solid sample + accelerator
in ceramic crucible

Induction heating of the sample
Excess O₂ provided to sample

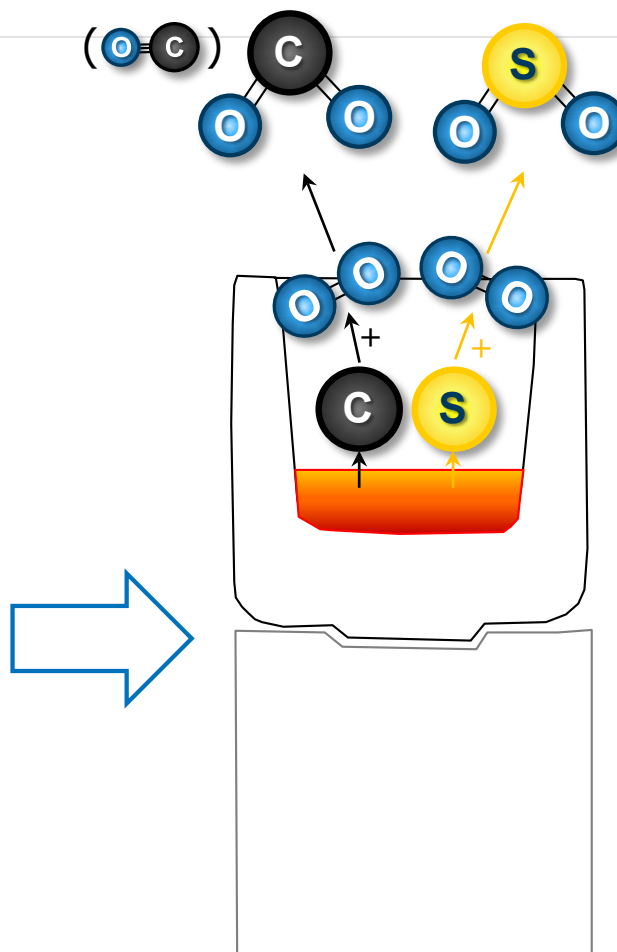
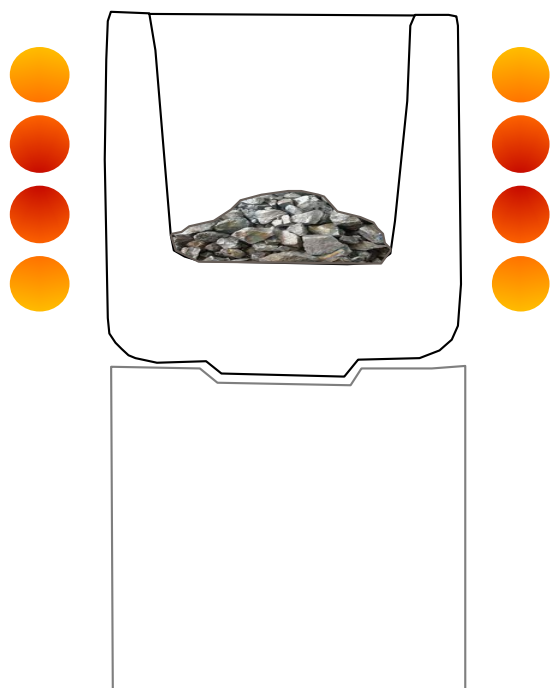

G4 ICARUS Series 2

Method Benefits



Combustion Analysis by HF-induction is:

- **Volumetric method:** Entire sample mass is analyzed
 - Also **applicable to difficult samples** with uneven distribution of elements (e.g. C in grey cast iron)
- Provides high **precision** and **accuracy**
- **Fast:** Analysis in ~ 60s
- Applicable over the **full concentration range** (from sub-ppm to 100%, by varying sample mass)
- **Flexible** in sample type, mass and form (powder, pieces, chips, drillings, etc.)
- **Easy** to operate

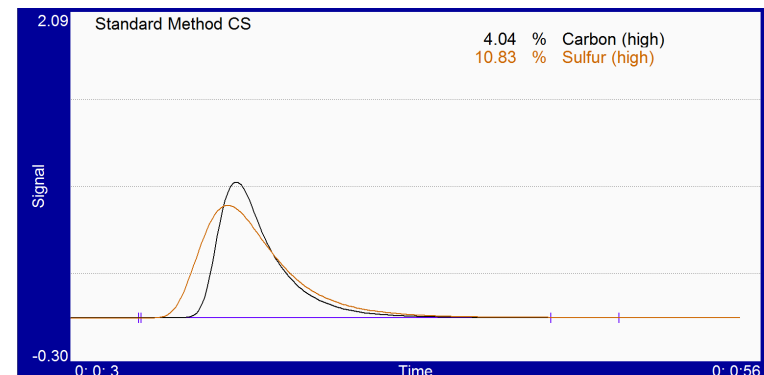

G4 ICARUS Series 2

A dirty affair...



The dark side of combustion

- Not only oxidation of C and S, but also of sample and accelerator
- ⇒ can create fine dust
- Fine dust can act as a column to retain analyte delivery to the detectors dependent on amount and type of dust.
- Production of spraying particles and liquid metal splatters due to vigorous combustion
- ⇒ can damage quartz combustion tube

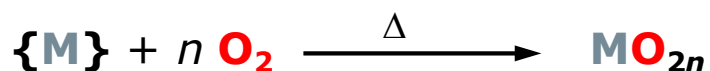

Metals/Minerals + O₂
= particulate oxides = **DUST**



G4 ICARUS Series 2

Intelligent Design: ZoneProtect™



ZoneProtect™

- More efficient combustion on a wider variety of samples
- Superior gas flow design for better analytical quality
 - ⇒ Oxygen supply through annular flow gap & turbulences ensure **perfect oxygen supply** to the sample
- Combustion gases, dust & particles transported through the extraction nozzle upward
- Reduces splattering, maximizes component lifetime (combustion tube)
- Integrated auto cleaner

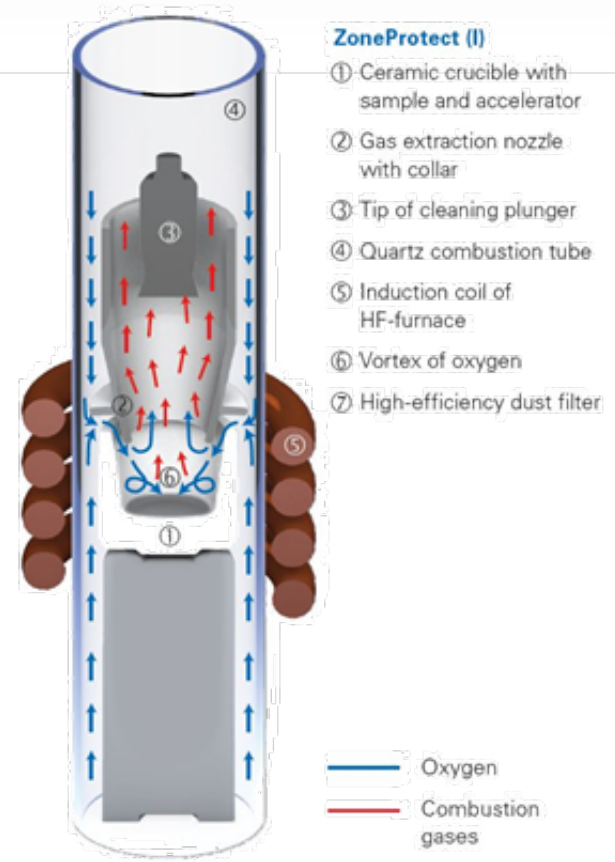

G4 ICARUS Series 2

Easy Maintenance: ZoneProtect™



Integrated dust removal system:

- Vacuum & noise-free cleaning system
- Waste disposal into the used crucible
- Brush-free cleaning operated by solid plunger
- High efficiency, integrated dust filter (3µm pore size) for cleaner environment and improved analytical precision
- Tool-free & easy maintenance



Efficient dust removal into the crucible

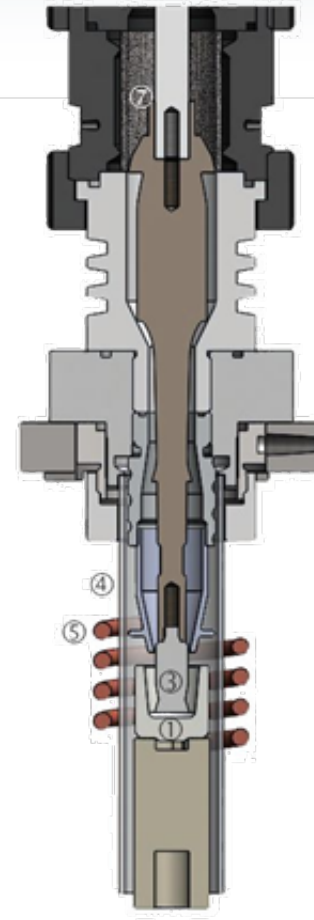

G4 ICARUS Series 2

Gas Flow Diagram



GAS FLOW DIAGRAM - G4 ICARUS HF CS (SERIES 2)

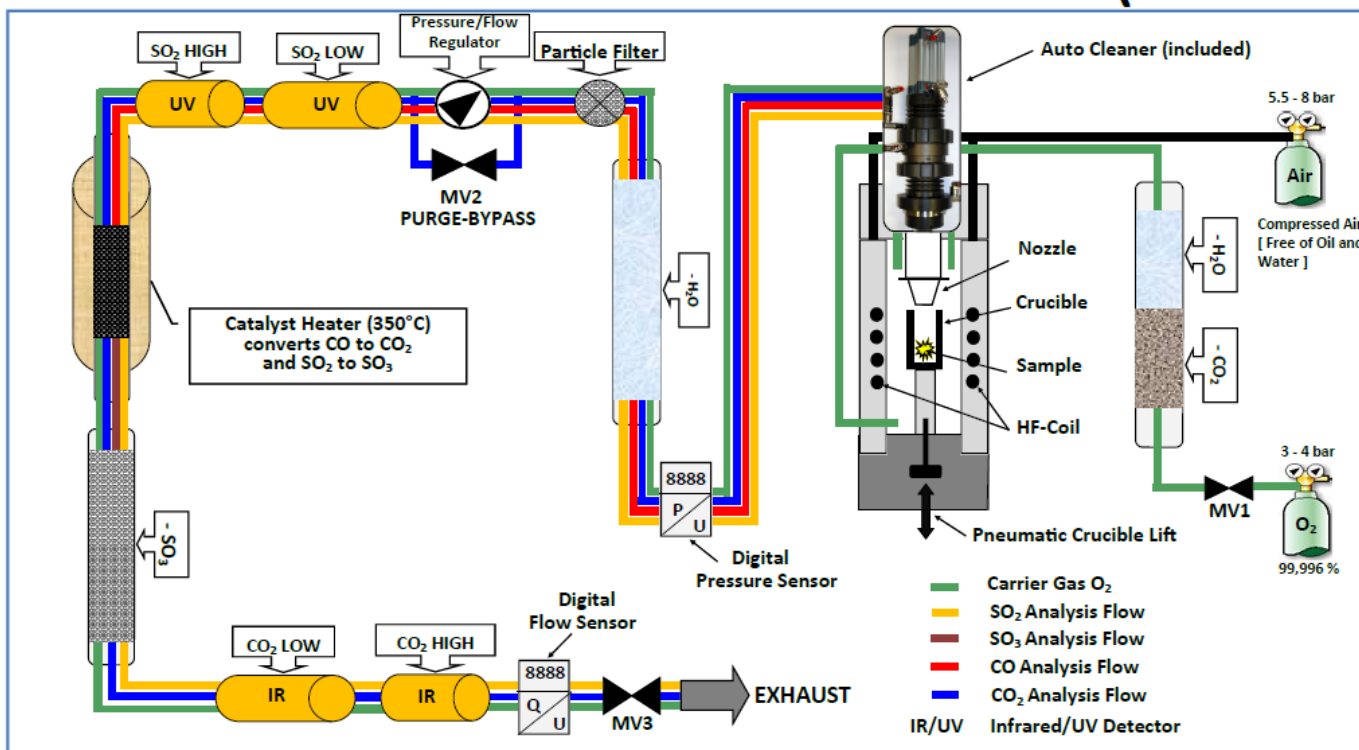

Bruker AXS GmbH
 Östl. Rheinbrückenstr. 49
 76187 Karlsruhe
 Germany

Phone +49 (721) 50997-0
 Fax +49 (721) 50997-5654
 info.baxs@bruker.com.de
 www.bruker.com



Rev_D6_2019_CHZ/KS

Case Studies

O, N and H in AlSi10Mg powders I

- Six **different lots** of AlSi10Mg - from 2 years
- Same supplier/manufacturer of laser beam machine
- Identical specification - but no O,N,H given
- Fresh powder
- $n=5$, one STD in brackets as measure for homogeneity

Lot (year)	Oxygen / ppm	Nitrogen / ppm	Hydrogen / ppm
A (2016)	1323 (187)	55 (6)	56 (4)
B (2016)	1730 (45)	42 (14)	57 (3)
C (2017)	1074 (71)	66 (24)	56 (6)
D (2017)	1378 (100)	55 (9)	64 (3)
E (2017)	937 (18)	48 (14)	46 (3)

Case Studies

O, N and H in AlSi10Mg powders II

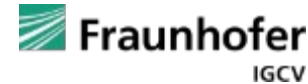

- Identical specification - but no O,N,H given
- Five **different suppliers**, same year
- Fresh powder
- $n=5$, one STD in brackets as measure for homogeneity

Supplier	Oxygen / ppm	Nitrogen / ppm	Hydrogen / ppm	Comment
1	1378 (100)	55 (9)	64 (3)	
2	1106 (79)	25 (9)	69 (4)	
3	2594 (119)	41 (9)	94 (6)	obtrusive in AM
4	1004 (135)	28 (9)	47 (2)	
5	1328 (43)	17 (6)	62 (5)	

Best quality AlSi10Mg \Rightarrow O: ≤ 1000 ppm, H: ~ 50 ppm

CS/ONH in AM Powders

Motivation



From the AM user perspective the powder metal market is complex and non-transparent:

- Manufacturers of AM machines offer their own powder
- Premium powder manufacturers
- Smaller primary metal manufacturers starting own powder productions

Chemical Composition of Metal Powders

- Alloying elements and material grade is given and specified (often verified multiple times but can vary during the process)
- Light elements like C, S, O, N, H, and Ar are rarely listed
- Hydrogen and Argon are ignored (except: NADCAP)
- No quality threshold values are defined (no studies about eldering or reused of powders)

→ Lack of knowledge regarding initial C,S /O,N,H, & Ar contents of commercially available powders for powder bed fusion processes!

CS/ONH/Ar in AM powders

Conclusions



- Oxygen, Hydrogen, and Carbon are the most critical elements for quality and costs (e.g. recycling)
- Process and Quality Control of light elements necessary for process optimization
- Ideally: Specification of contaminants from atomization → requires testing before and after 3D printing (raw material vs. finished product)
- High quality AM processes require great care in choosing process gases (impurities) and evaluating the influence of contaminants such as **moisture**
- **Inert gas fusion** and **Combustion** are fast, effective and readily available analytical methods for process and quality control in powder metallurgical processes

The Additive Manufacturing (AM) Process

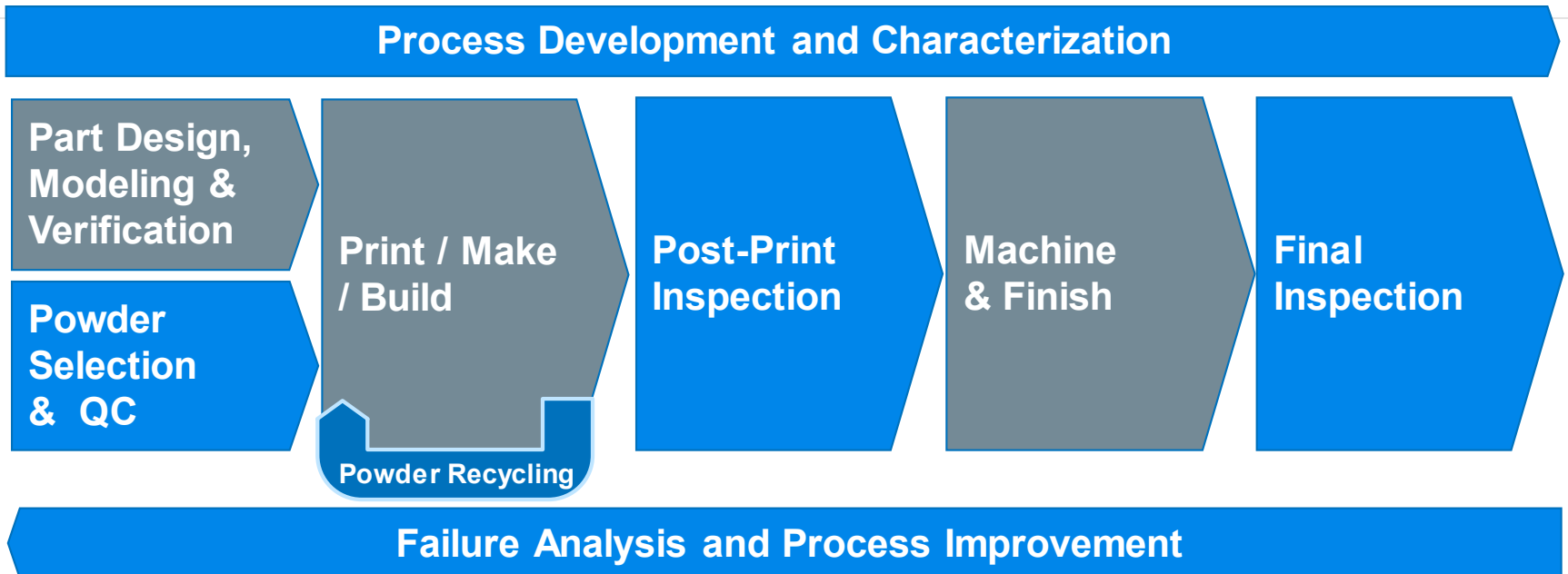

Bruker's Solutions provide critical insight to ensure your finished products meet requirements for **Auto, Aerospace, Medical** and other **high precision AM applications**.

\$\$ Issues in AM Critical for Yield and Quality



Powder



New Powder

- Up to 90% Waste
- O/H/Ar Contamination

Recycled Powder

- O/H/Ar Contamination
- Particle Deformation

Post-Print

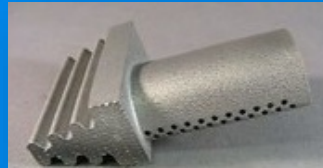

Geometrical Variation

- Overhang
- Calibration Issues
- Deformation

Bulk Defects / Variation

- Voids
- Inclusions
- Delamination
- Cracking
- Microstructure variation

Surface Texture Variation

Post-Finish



Geometric Variation

- Misperrocessing
- Process design error

Surface Finish Variation

- Roughness
- Uniformity

Application



MTBF / MTBR

- Wear
- Breakage
- Deformation

Bruker's Solutions enable optimum process control to help **maximize AM Profits**

\$\$ Issues in AM Critical for Yield and Quality

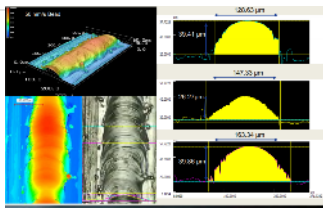

Roughness Variation from Layer Formation

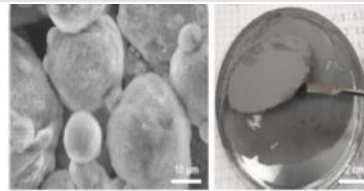

Powder H2O (Hydroxide) Contamination & Caking⁴



Swelling & Melt Balling³

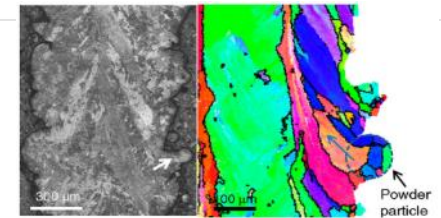

Roughness Variation / Edge Grain Nucleation¹

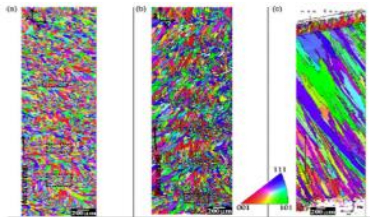

Grain Structure Variation¹

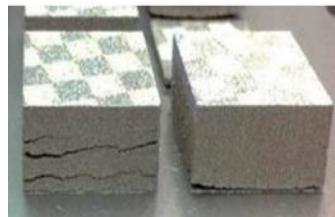

Delamination & cracking by Lack of Fusion & Stress¹

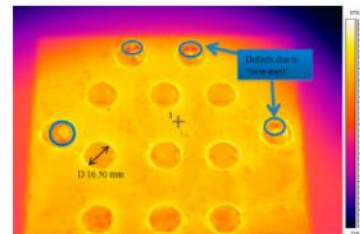

Feature Deformation from Overmelt¹

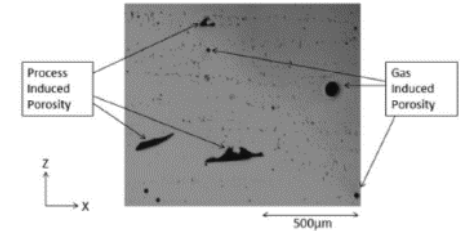

Voids & Porosity Variation¹

Bruker's Solutions enable optimum process control to help **maximize AM Profits**

Bruker Technologies for Elemental & Structural Analysis



X-Ray Fluorescence (XRF)
Elemental composition &
mapping



S8 TIGER

Inert Gas Fusion –
Mass Spectrometry (IGF-MS)
O, N, H & Ar detection



G8 GALILEO

Combustion Gas Analysis (CGA)
C and S analysis in solids



G4 ICARUS

Electron Microscope
Analyzers (EMA)
Highest resolution Imaging
Topographical & material
analysis



EM ANALYZERS

Micro Computed Tomography (μ CT)
Metrology
Non-destructive inspection
CAD comparison

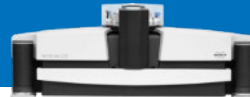

SKYSCAN 1272

X-Ray Diffraction (XRD)
Phase composition
Texture
Residual stress



D8 DISCOVER

Mechanical/Tribology Test (UMT)
Wear rates & resistance
Friction
Load
Hardness



UMT TRIBOLAB

Nano Indentation (NI)
Mechanical homogeneity
Fracture
Surface energy
agglomeration



TI 980 TRIBOINDENTER

3D Optical Microscopy
Roughness
Metrology
Surface geometry
& shape



NP FLEX

Bruker Solutions for Additive Manufacturing

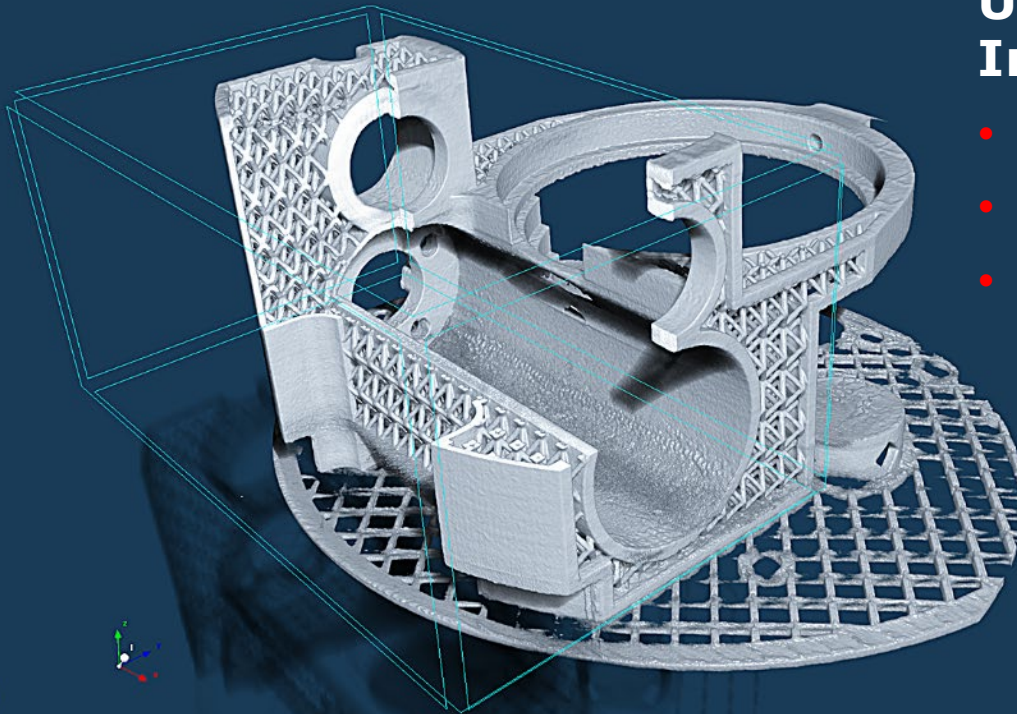

Unmatched Innovation for Inspection & Characterization

- **Process Development**
- **Materials**
- **Parts & Components**

SPECIAL THANKS



Christian Zühlke

Bruker AXS GmbH, Karlsruhe, Germany

Business Development Manager CS / ONH Analysis



Dr. Katharina Schweitzer

Bruker AXS GmbH, Karlsruhe, Germany

Application Scientist CS / ONH Analysis

Q & A Session



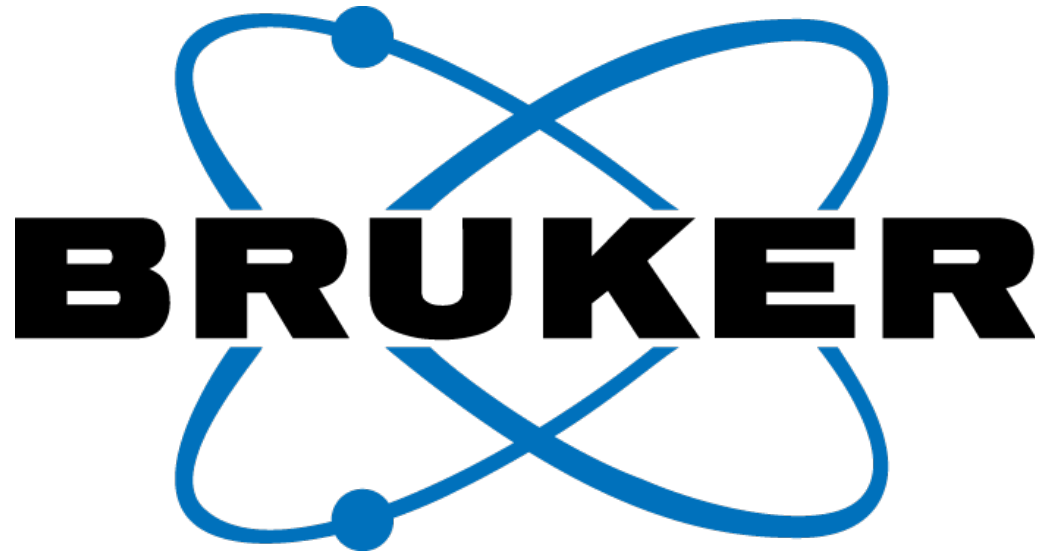

Innovation with Integrity